

# UV sensor UVS 10

Technical Information · GB

8.2.1 Edition 08.09

CE



krom  
schroder

- Suitable for small burners due to high sensitivity
- Virtually immune to interference due to its insensitivity to daylight, infrared radiation and incandescent bulbs
- Maximum safety thanks to protection against discontinuity or short-circuit on the flame signal cable
- Lower logistics costs as the UVS 10 replaces several previous models
- Suits industrial needs due to robust design
- Complies with the requirements of EN 298 in conjunction with Elster Kromschöder automatic burner control units

## Table of contents

|  |    |
|--|----|
| UV sensor UVS 10 .....                               | 1  |
| Table of contents .....                              | 2  |
| 1 Application .....                                  | 3  |
| 2 Certification .....                                | 4  |
| 3 Function .....                                     | 5  |
| 3.1 Connection diagram .....                         | 5  |
| 4 Replacement possibilities .....                    | 6  |
| 5 Selection .....                                    | 6  |
| 5.1 Type code .....                                  | 6  |
| 6 Project planning information .....                 | 7  |
| 6.1 Installation .....                               | 7  |
| 6.2 Intensifying weak UV radiation .....             | 7  |
| 7 Accessories .....                                  | 8  |
| 7.1 Adapter UVS 1 with quartz glass disc .....       | 8  |
| 7.2 Cooling air adapter with quartz glass disc ..... | 8  |
| 7.3 Quartz glass disc with seals .....               | 8  |
| 7.4 UV tube .....                                    | 8  |
| 8 Technical data .....                               | 9  |
| 8.1 Dimensions .....                                 | 9  |
| 9 Maintenance cycles .....                           | 9  |
| Feedback .....                                       | 10 |
| Contact .....  | 10 |

## 1 Application

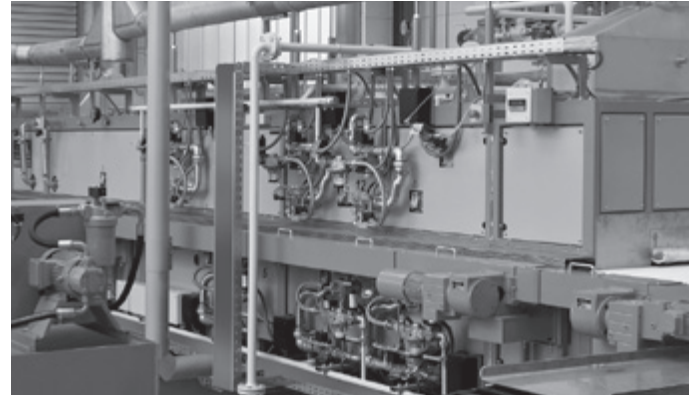
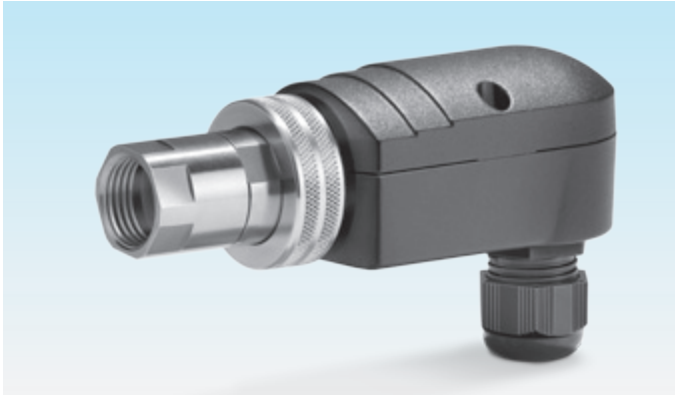

For monitoring gas burners of unlimited capacity with or without fan, on hot-air furnaces, gas-fired boilers, industrial furnaces and excess-gas flaring installations in conjunction with Elster Kromschöder burner control units and automatic burner control units.

The UV sensor monitors the gas burners in intermittent operation.

The burners can either be ignited directly or operated as pilot and main burners.

UV sensors UVS 1, UVS 6 and UVS 8 can be replaced by using various adapters.

## 2 Certification



For certification, see Technical Information of the corresponding automatic burner control unit or burner control unit that the UV sensor is to be used with.

## 3 Function

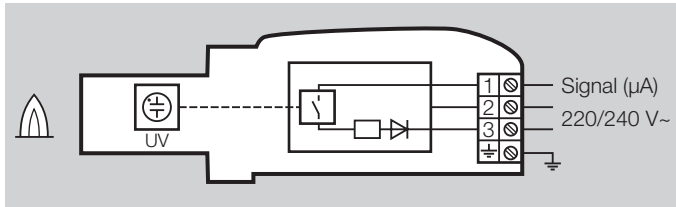

The UV tube detects the ultraviolet light of a flame. It therefore does not respond to daylight, incandescent bulb light or infrared radiation emitted by hot workpieces or red-hot furnace walls.

An integrated quartz glass heat guard insulates the internal UV tube against the hot furnace atmosphere and protects against moisture, dirt and heat.

The service life of the UV tube is approximately 10,000 operating hours. For safety reasons, it must be replaced after this period.

The UV tube is operated with an alternating voltage of 220/240 V. The voltage is provided by the automatic burner control unit or the flame detector.

In the case of incident UV light, alternating current flows through the UV tube and is converted into a DC signal by a rectifier. The flame signal amplifier only responds to direct current.

## 3.1 Connection diagram

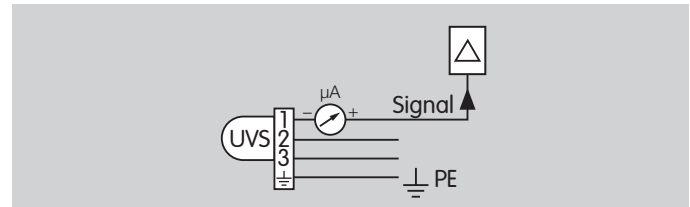

Wire the UV sensor according to the connection diagram of the relevant automatic burner control unit or flame detector. A grounded mains is not required.

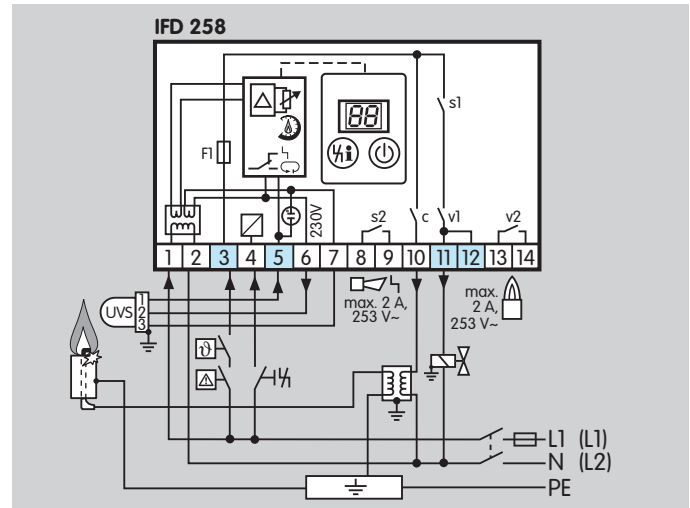

Electrical connection using the example of automatic burner control unit IFD 258

## 4 Replacement possibilities

UVS 1 is to be replaced by UVS 10D4G1  
(be sure to install new connection cables).

UVS 6 is to be replaced by UVS 10D0G1.

UVS 8 is to be replaced by UVS 10D2  
(be sure to install new connection cables).

Replacement for UVS 5 available on request.

## 5 Selection

| Type     | G1* |
|----------|-----|
| UVS 10D0 | ●   |
| UVS 10D1 | ●   |
| UVS 10D2 |     |
| UVS 10D3 |     |
| UVS 10D4 | ●   |
| UVS 10L0 | ●   |
| UVS 10L1 | ●   |
| UVS 10L2 |     |
| UVS 10L3 |     |

**Order example**  
UVS 10L0G1

\* If "none", this specification is omitted. ● = standard, ○ = available

### 5.1 Type code

| Code | Description  |
|------|--|
| UVS  | UV sensor  |
| 10   | Series 10  |
| D    | Quartz glass heat guard                            |
| L    | Quartz glass heat guard lens                       |
| 0    | Rp 1/2 internal thread                             |
| 1    | Rp 1/2 internal thread and cooling air connection  |
| 2    | 1/2 NPT internal thread                            |
| 3    | 1/2 NPT internal thread and cooling air connection |
| 4    | UVS 1 adapter (28 mm (1.1"))                       |
| G1   | <b>Electrical connection</b><br>M20 cable gland    |

## 6 Project planning information

### 6.1 Installation

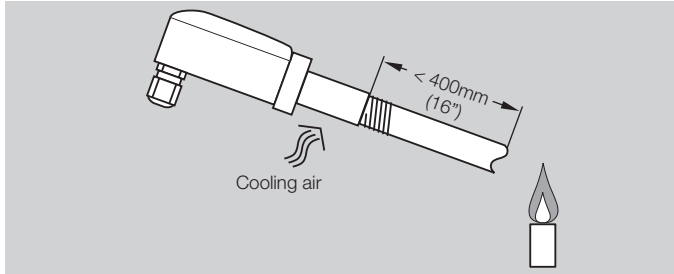

It can be fitted using a 1/2" viewing tube that should be aligned on the first flame third, as this is where the highest UV radiation is generally found. The inside of the steel tube should not be coated and the tube should be directed at the flame from above so that no dirt collects in front of the UV sensor.

The UV sensor may only be exposed to the light of its own flame. It should be protected from other sources of ultraviolet light. These could be, for example: neighbouring flames (this must be observed when monitoring pilot and main burners in particular), ignition sparks, arcs from welding devices or lamps emitting ultraviolet light.

Do not expose the UV sensor viewing opening to direct sunlight.

Supply cooling air to cool and protect the optical system from soiling and condensation.

### 6.2 Intensifying weak UV radiation

The quartz glass is designed to protect the UV tube and is available as a lens in order to concentrate weak UV radiation more effectively and to achieve a stronger UV signal. Thereby, the UV sensor must be precisely aligned with the flame.

Quartz glass lens, see „Accessories“ (p 8).

## 7 Accessories

### 7.1 Adapter UVS 1 with quartz glass disc

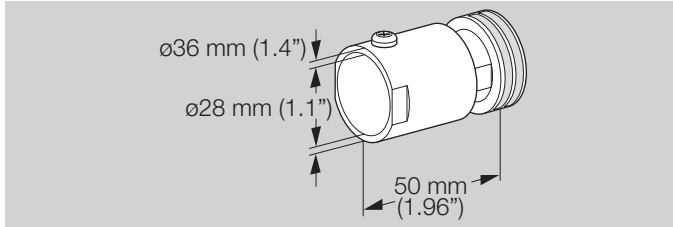

Order No.: 7 496 061 5

### 7.2 Cooling air adapter with quartz glass disc

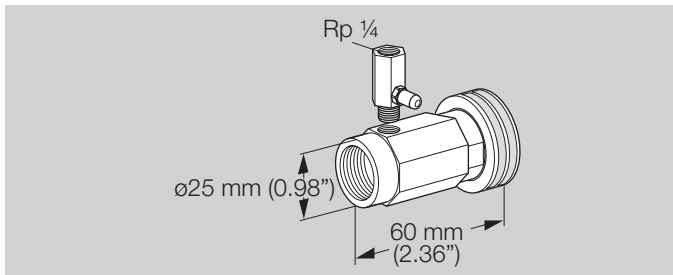

Rp 1/2, Order No.: 7 496 061 4

1/2 NPT, Order No.: 7 496 061 3

Nozzle for cooling air adapter, Order No.: 7 496 061 6

### 7.3 Quartz glass disc with seals



Order No.: 7 496 061 2

Lens, Order No.: 7 496 061 1

### 7.4 UV tube

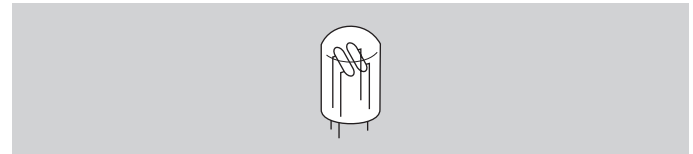

Order No.: 7 496 044 5



## 8 Technical data

Aluminium housing with integrated heat guard,  
with connection terminals.

Distance between UV sensor and flame: 300–400 mm.

UV tube: P578,  
spectral range: 190–270 nm,  
max. sensitivity: 210 nm  $\pm$  10 nm.

Service life of the UV tube: approx. 10,000 operating hours.

Min. DC signal: 1  $\mu$ A.

Enclosure: IP 65.

Ambient temperature: -40 to +80°C (-40 to +176°F).

Weight: 280 g (0.6 lbs).

Max. length of cable UV sensor – automatic burner control  
unit:

see instructions for automatic burner control unit.

### 8.1 Dimensions

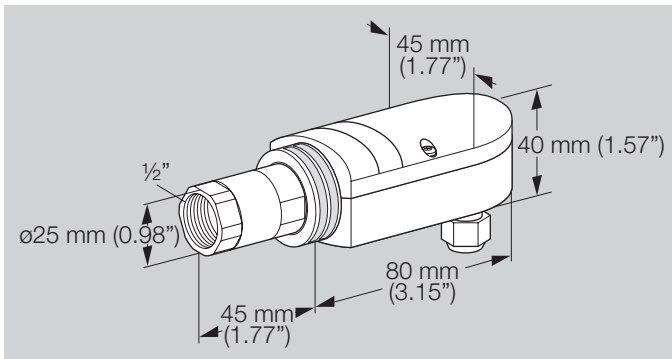

## 9 Maintenance cycles

Service life of the UV tube: 10,000 operating hours.

The UV tube must be replaced after this period, see „Accessories“ (p 8).

## Feedback

Finally, we are offering you the opportunity to assess this “Technical Information (TI)” and to give us your opinion, so that we can improve our documents further and suit them to your needs.

### Clarity

- Found information quickly
- Searched for a long time
- Didn't find information
- What is missing?
- No answer

### Comprehension

- Coherent
- Too complicated
- No answer

### Scope

- Too little
- Sufficient
- Too wide
- No answer

### Use

- To get to know the product
- To choose a product
- Planning
- To look for information

### Navigation

- I can find my way around
- I got “lost”
- No answer

### My scope of functions

- Technical department
- Sales
- No answer

### Remarks

(Adobe Reader 7 or higher required)

## Contact

Elster GmbH  
 Postfach 2809 · 49018 Osnabrück  
 Strotheweg 1 · 49504 Lotte (Büren)  
 Germany  
 T +49 541 1214-0  
 F +49 541 1214-370  
 info@kromschroeder.com  
 www.kromschroeder.com  
 www.elster.com

The current addresses of our international agents are available on the Internet:  
[www.kromschroeder.com](http://www.kromschroeder.com) → Sales

Kromschöder, a product brand of the Elster Group 

We reserve the right to make technical modifications in the interests of progress.  
 Copyright © 2007 – 2009 Elster Group  
 All rights reserved.