

Pressure switch for gas DG..C

TECHNICAL INFORMATION

- Little space required thanks to compact dimensions
- Double pressure switch for minimum and maximum gas pressure monitoring in one unit
- Customized versions with fixed switching points can be supplied by agreement
- Several connection facilities using various lower sections
- Available with sealant-coated external thread
- Certified for systems up to SIL 3 and PL e



Contents

Contents	2
1 Application	3
1.1 Application examples	5
2 Certification	7
3 Function	8
3.1 DG..C in Zone 1 (21) and 2 (22) hazardous areas	8
4 Selection	10
4.1 Selection table	10
4.2 Type code	10
4.2.1 Attachment methods	11
5 Project planning information	12
5.1 Installation	12
5.2 Wiring	12
6 Accessories	14
6.1 Restrictor orifice	14
6.2 PIA	14
7 Technical data	15
7.1 Adjusting range, switching hysteresis	15
7.2 Safety-specific characteristic values for DG..C	16
7.3 Dimensions	18
7.4 Converting units	18
8 Maintenance cycles	19
9 Glossary	20
9.1 Diagnostic coverage DC	20
9.2 Mode of operation	20
9.3 Category	20
9.4 Common cause failure CCF	20
9.5 Fraction of undetected common cause failures β	20
9.6 B_{10d} value	20
9.7 T_{10d} value	20
9.8 Hardware fault tolerance HFT	20

9.9 Mean dangerous failure rate λ_D	20
9.10 Safe failure fraction SFF	21
9.11 Probability of dangerous failure PFH_D	21
9.12 Mean time to dangerous failure $MTTF_d$	21
9.13 Demand rate n_{op}	21
9.14 Average probability of dangerous failure on demand PFD_{avg}	21
Fore more information	22

1 Application

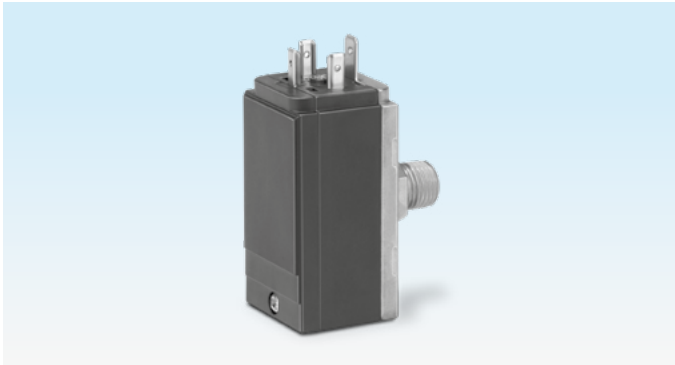

DG..C
The switching point can be set at the factory on request



DG..VC
With hand wheel for continuous switching point adjustment

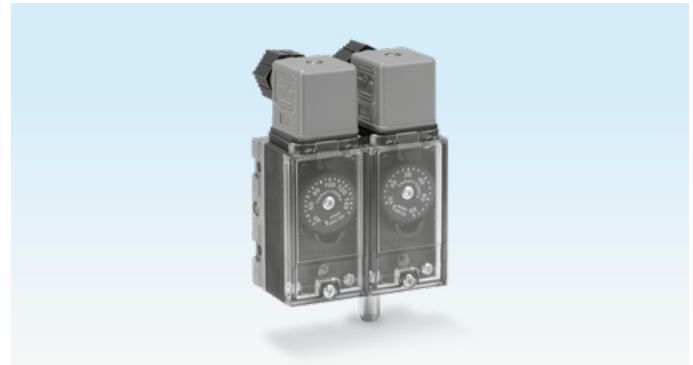

DG../.VC
Double pressure switch with hand wheels for min. and max. switching point adjustment



DG..VCT, DG..VCFT
FM approved and UL listed

DG..C monitors the increasing or decreasing positive pressure of natural gas, town gas, LPG, flue gas, biologically produced methane and air e.g. on a gas control line.

Application

If the gas pressure either exceeds or falls short of a set switching point, an NO contact or a change-over contact will switch in the pressure switch. With the DG..VC, the switching point may be adjusted using a hand wheel, see page 15 (Adjusting range, switching hysteresis).

The DG..VC is suitable for heating boilers, for example, which are operated with LPG as well as natural gas.

In the case of the double pressure switch DG../.VC, the minimum and maximum switching point can be set on two hand wheels. Using this function, a system is controlled to prevent gas deficiencies and excess gas pressure. For pressure control it requires only one gas connection. The electrical connections can be fed in from one direction, see page 12 (Wiring).

For attachment to gas solenoid valves or pressure regulators from the valVario range, or to CG combination controls, the DG..C is attached to the control with the flat sealing lower section.

The pressure switch DG..C is easy to install and is available with an internal or an external thread connection. For the external thread connection, the DG..C can be provided with a sealant. The sealant is approved and non-setting.

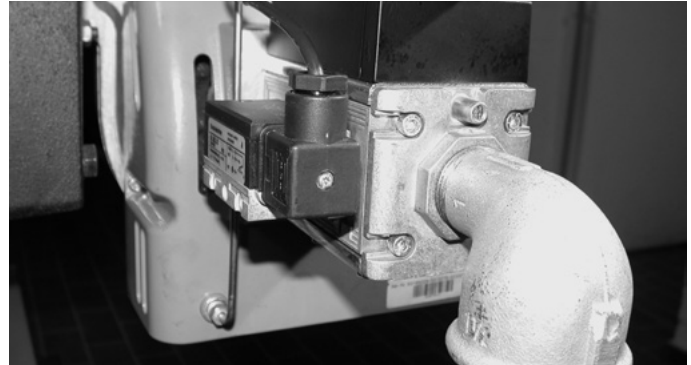

For monitoring the gas inlet pressure on heating burners



Gas inlet pressure monitoring on high-performance boilers



Compact design for space-saving installation, e.g. on valVario controls

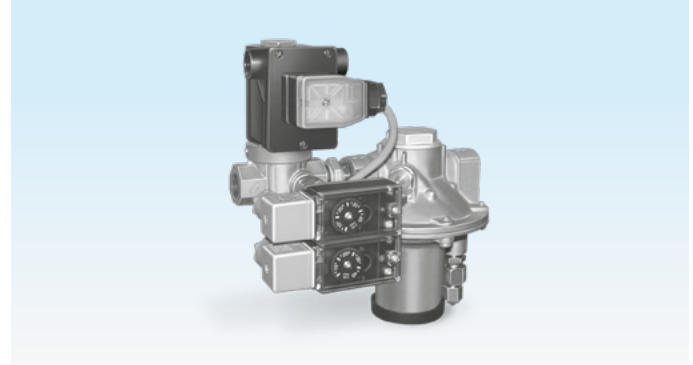

Double pressure switch DG..VC fitted onto gas solenoid valve VG



Gas train in a brickworks

1.1 Application examples

Boilers

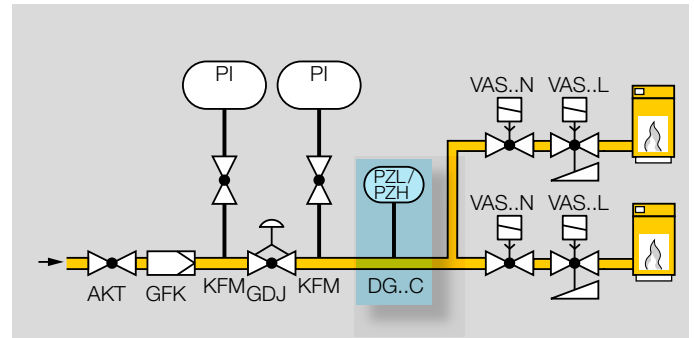

The DG..C controls the minimum or maximum gas inlet pressure on high-performance boilers.

Low-pressure cut-off and high gas pressure protection device

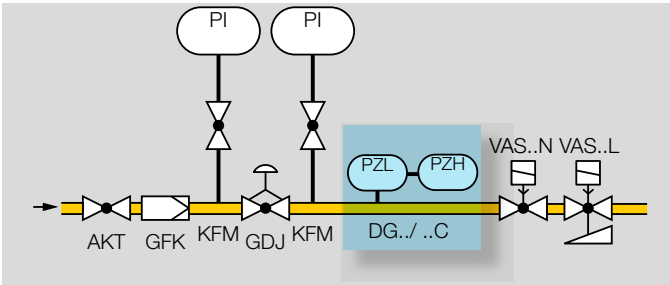

If the pressure is either too high or too low, the double pressure switch DG../..C switches in order to avoid start-up or to initiate a safety shut-down.

Fan monitoring

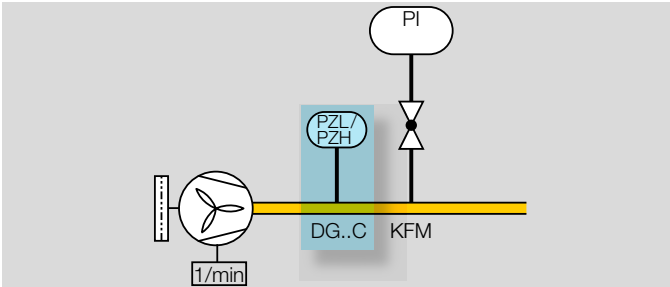

On forced draught burners, the minimum or maximum pressure is retrieved by the burner control unit via the pressure switch DG..C. If the set switching point is exceeded or undershot, the fan will either be switched on or off by the burner control unit.

2 Certification

Certificates – see www.docuthek.com

Certified to SIL and PL



For systems up to SIL 3 pursuant to EN 61508 and PL e pursuant to ISO 13849

EU certified pursuant to



- 2014/35/EU (LVD)–Low Voltage Directive
- 2014/30/EU (EMC)–Electromagnetic Compatibility Directive
- (EU) 2016/426 (GAR)–Gas Appliances Regulation
- EN 13611:2015+AC:2016
- EN 1854:2010

AGA approved



Australian Gas Association, Approval No.:5484
http://www.aga.asn.au/product_directory

Eurasian Customs Union



The product DG..C meets the technical specifications of the Eurasian Customs Union.

FM approved



Factory Mutual Research Class: 3510 Flow and pressure safety switches. Designed for applications pursuant to NFPA 85 and NFPA 86. www.approvalguide.com

UL listed, DG..CT, DG..CFT with socket

USA and Canada



Underwriters Laboratories – UL 353 Limit control. www.ul.com – Tools (at the bottom of the page) – Online Certifications Directory

UR approval, DG..CT, DG..CFT without socket

USA and Canada



Underwriters Laboratories – UL 353 Limit control. www.ul.com – Tools (at the bottom of the page) – Online Certifications Directory

3 Function

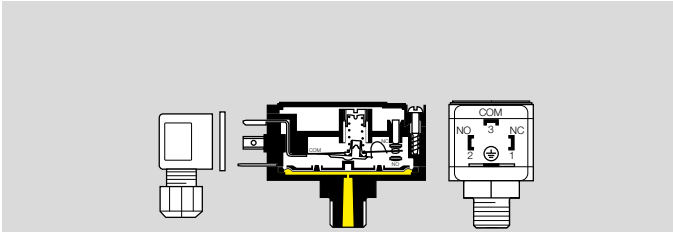

The pressure switch DG..C switches in the event of increasing or decreasing pressure. Once the set switching point is reached, a micro switch is activated in the DG..C which is designed as an NO contact (DG..C..S) or as a change-over contact (DG..C..W).

The scale values show the switch-off point for DG..VC and the switch-on point for DG..VCT.

Observe contact position for decreasing/increasing pressure control:

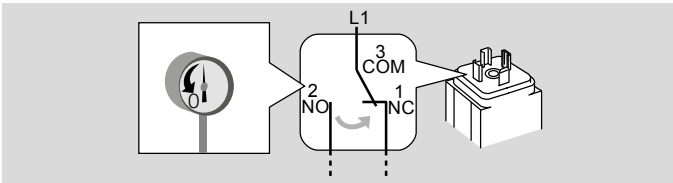

With the change-over contact, the contact switches from NO 2 to NC 1 for decreasing pressure control, from NC 1 to NO 2 for increasing pressure control.

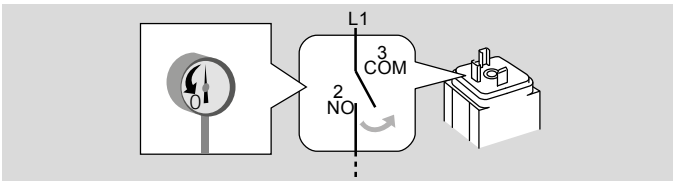

With the NO contact, NC is omitted. The contact opens for decreasing pressure control, and closes for increasing pressure control.

3.1 DG..C in Zone 1 (21) and 2 (22) hazardous areas

Pressure switch DG..C can be used in Zone 1 (21) and 2 (22) hazardous areas if an isolating amplifier is installed upstream in the safe area as “Ex-i” equipment pursuant to EN 60079-11 (VDE 0170-7):2012.

DG..C as “simple electrical equipment” pursuant to EN 60079-11:2012 corresponds to the Temperature class T6, Group II. The internal inductance/capacitance is $L_i = 0.2 \mu\text{H}/C_i = 8 \text{ pF}$.

The isolating amplifier transfers the DG..C signals from the explosion-hazard area to the safe area. Depending on the design of the intrinsically safe circuit, the explosion-hazard area can be monitored for cable faults, cable breaks or short-circuits.

Ensure that standard-compliant wiring pursuant to EN 60079 is used.

Intrinsically safe circuit without monitoring for cable faults

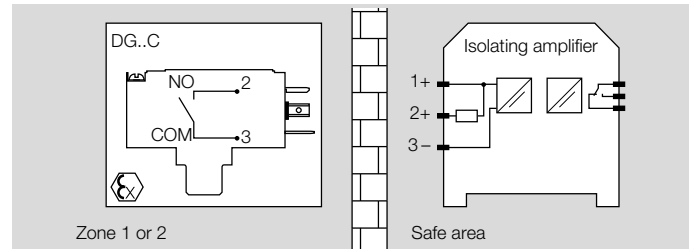

Intrinsically safe circuit with monitoring for cable breaks

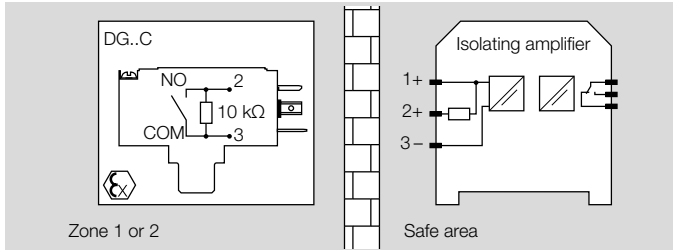

Intrinsically safe circuit with monitoring for cable faults and short-circuits

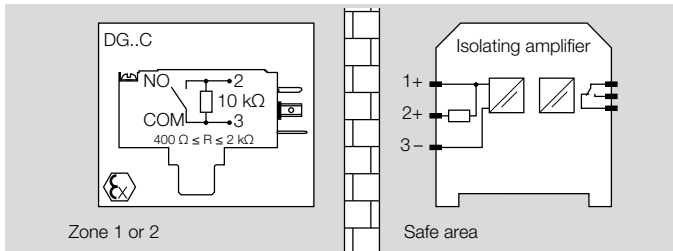

4 Selection

4.1 Selection table

Option	DG without hand wheel	DG with hand wheel
Setting range 15 – 500	15, 35, 110 , 250, 360	17, 30, 40, 45, 60, 110, 150, 300, 500
2nd setting range 15 – 500	/15, /35, /110, /250, /360	/17, /30, /40, /45, /60, /110, /150, /300, /500
Hand wheel		V
Version	C , CT	C, CT, CFT
Attachment method	1, 3, 4 , 5, 6, 8, 9	1, 3, 4, 5, 6, 8, 9
Sealant	D ¹⁾	D ¹⁾
El. connection	-5, -6	-5, -6
Contact	S, W	S, W
With gold-plated contacts	G	G

¹⁾ Wenn „ohne“, entfällt diese Angabe

Order example

DG 110C4-6W

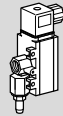

4.2 Type code

DG	Pressure switch for gas
15–500	Max. setting in mbar
/15–/500¹⁾	Max. 2nd setting in mbar
V	Switching point adjustable on hand wheel
C	EU version, switches with falling pressure
CT	US version, switches with rising pressure
CFT	US version, switches with falling pressure
1	Connection for valVario
4²⁾	2 x Rp 1/4 internal thread (1/4 NPT), 1 x pressure test point
5²⁾	Rp 1/4 internal thread (1/4 NPT)
6	Rp 1/8 external thread (1/8 NPT)
8	Rp 1/4 external thread (1/4 NPT)
9	Optional connection for valVario controls
D	Sealant (for external thread only)
-5²⁾	4-pin plug, without socket
-6³⁾	4-pin plug, with socket
S	NO contact
W	Change-over contact
G	With gold-plated contacts

¹⁾ Double pressure switch only available with 2 x Rp 1/4 internal thread connection, of which 1 has a pressure test point attached.

²⁾ DG..VC..T with 4-pin plug, without socket is UR recognized.

³⁾ DG..VC..T with 4-pin plug, with socket and connection leads is UL listed.

4.2.1 Attachment methods

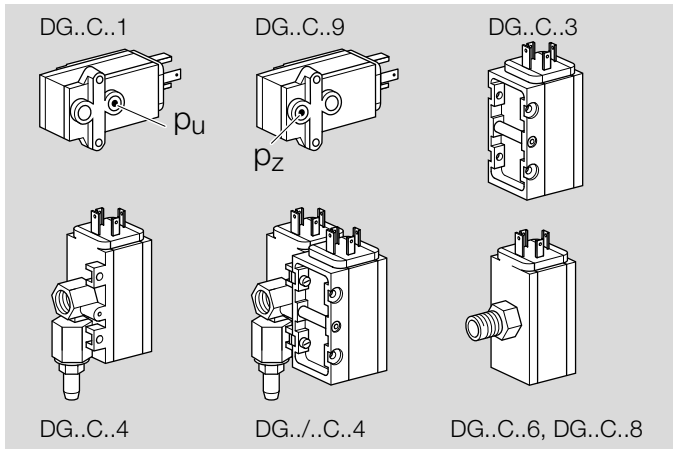

For further information on DG..C..1, inlet pressure connection p_u , and DG..C..9, interspace pressure connection p_z , see page 12 (Installation).

5 Project planning information

5.1 Installation

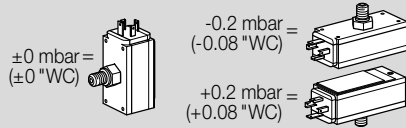

Installation in the vertical or horizontal position. If installed in a horizontal position, the pre-set switching point will change by 0.2 mbar (0.08 °WC). If the DG..C is installed with the plug pointing downwards, the enclosure is reduced to IP 40, see page 15 (Adjusting range, switching hysteresis).

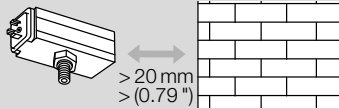

The DG..C must not be in contact with masonry. Minimum clearance 20 mm (0.79 inches).

Ensure that there is sufficient installation space. With the pressure switch DG..VC, the adjustment and reading of the hand wheel must be guaranteed

DG..C..4

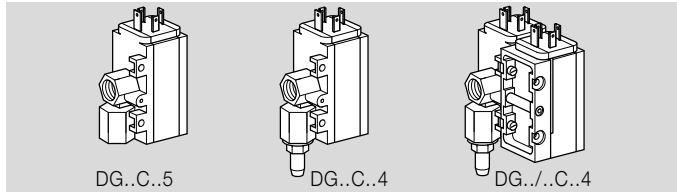

The lower housing sections with Rp 1/4 (NPT 1/4) internal thread are compatible with series DG..U, B, H, N.

DG..C..1, DG..C..9 for valVario controls

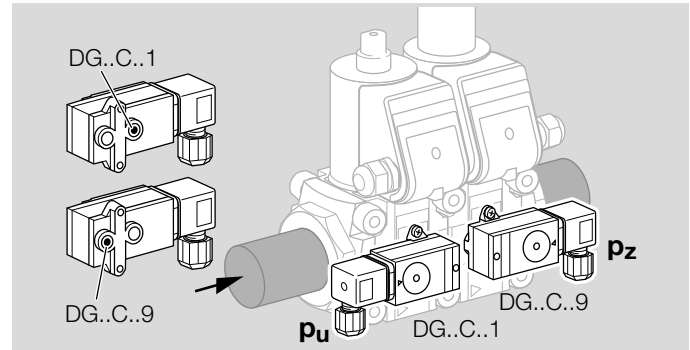

If when monitoring the inlet or outlet pressure and the interspace pressure both pressure switches should be fitted on the same side of the valve, only the combination DG..C..1 and DG..C..9 may be used for design reasons. The socket for the gas pressure switch DG..C..1 points towards the test point p_u (towards the inlet flange). The DG..C..9 is also optionally available for monitoring the interspace pressure p_z . The socket points towards the outlet flange.

5.2 Wiring

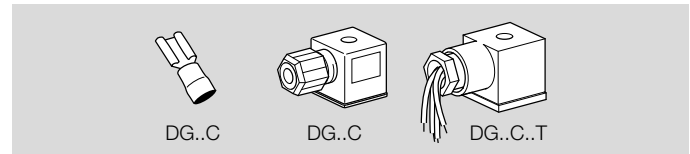

The pressure switches DG..C can be connected electrically using a tab receptacle (4.8 × 0.8) or using a socket. They are available with an NO contact or a change-over contact.

Project planning information

The pressure switch DG..CT, DG..CFT is connected electrically via a socket with ½" NPT thread and pre-wired connection leads. It is supplied with a change-over contact.

6 Accessories

6.1 Restrictor orifice

For CE certified pressure switches

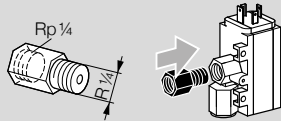

In case of high pressure fluctuations, we recommend using a restrictor orifice.

Order No.: 75456321

6.2 PIA

For CE certified pressure switches

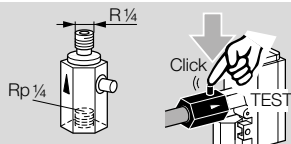

To test the pressure switch, the DG..C..4, DG..C..5 can be vented using the PIA test key.

Order No.: 74329466

7 Technical data

Gas type: natural gas, town gas, LPG (gaseous), flue gas, biologically produced methane (max. 0.1 %-byvol. H₂S) and air.

Max. inlet pressure p_{\max} = withstand pressure = 600 mbar (8.5 psig).

Max. test pressure for testing the entire system: temporarily \leq 15 minutes 2 bar (29 psig).

Switching capacity:

	U	I (cos φ =1)	I (cos φ =0.6)
DG..C	24–250 V~	0.05–5 A	0.05–1 A
DG..C..G	5–250 V~	0.01–5 A	0.01–1 A
DG..C..G	5–48 V =	0.01–1 A	0.01–1 A
DG..CT, DG..CFT	\leq 240 V~	\leq 5 A	\leq 0.5 A
DG..CTG, DG..CFTG	\leq 30 V~/=	\leq 0.1 A	\leq 0.05 A

If the DG..C..G (DG..T..G) has switched a voltage $>$ 24 V ($>$ 30 V) and a current $>$ 0.1 A at $\cos \varphi = 1$ or $>$ 0.05 A at $\cos \varphi = 0.6$ once, the gold plating on the contacts will have been burnt through. It can then only be operated at this power rating or higher power rating.

Maximum medium and ambient temperatures:

DG..C: -20 to +70°C (-4 to +158°F),

DG..CT: -15 to +60°C (5 to 140°F).

Long-term use in the upper ambient temperature range accelerates the ageing of the elastomer materials and reduces the service life (please contact manufacturer).

Storage temperature:

-20 to +40°C (-4 to +104°F).

Diaphragm pressure switch, silicone-free.

Diaphragm: NBR.

Housing: glass fibre reinforced PBT plastic with low gas release.

Lower housing section: AISi 12.

Enclosure:

IP 54 pursuant to DIN EN 60529 with standard socket to DIN EN 175301-803,
IP 00 with AMP plug.

Safety class: 1.

Weight: 60 g (2.12 oz).

Recommended tightening torque:

Component	Tightening torque [Ncm]
Cover screws	45
Socket	45

7.1 Adjusting range, switching hysteresis

DG..C, DG..VC

The scale value is set to the switch-off point

Type	Adjusting range* [mbar]	Switching hysteresis** [mbar]
DG 15C	3 – 15	0.7 – 2
DG 17VC	2 – 17	0.7 – 2
DG 30VC	8 – 30	1 – 2
DG 35C	5 – 35	1 – 2.5
DG 40VC	5 – 40	1 – 2.5
DG 45VC	10 – 45	1 – 2.5
DG 60VC	10 – 60	1 – 3
DG 110C	30 – 110	2 – 8
DG 110VC	30 – 110	2 – 8
DG 150VC	40 – 150	2 – 8
DG 250C	70 – 250	5 – 15

Type	Adjusting range* [mbar]	Switching hysteresis** [mbar]
DG 300VC	100 – 300	6 – 20
DG 360C	100 – 360	6 – 20
DG 500VC	150 – 500	20 – 50

DG..CT, DG..VCT, DG..VCFT

The scale value is set to the switch-off point

Type	Adjusting range* [“WC]	Switching hysteresis** [“WC]
DG 15CT	1.2 – 6.0	0.28 – 0.8
DG 17VCT, DG 17VCFT	0.8 – 6.8	0.28 – 0.8
DG 30VCT, DG 30VCFT	3.2 – 12.0	0.4 – 0.8
DG 35CT	2 – 14	0.4 – 1.0
DG 40VCT, DG 40VCFT	2 – 16	0.4 – 1.0
DG 45VCT, DG 45VCFT	4 – 18	0.4 – 1.0
DG 60VCT, DG 60VCFT	4 – 24	0.4 – 1.2
DG 110CT	12 – 44	0.8 – 3.2
DG 110VCT, DG 110VCFT	12 – 44	0.8 – 3.2
DG 150VCT, DG 150VCFT	16 – 60	0.8 – 3.2
DG 250CT	28 – 100	2.0 – 6.0
DG 300VCT, DG 300VCFT	40 – 120	2.4 – 8.0
DG 360CT	40 – 144	2.4 – 8.0

* Adjusting tolerance = ± 15% of the scale value. Deviation from the switching point during testing pursuant to EN 1854 Gas pressure switches: ± 15%.

** Mean switching differential at min. and max. setting.

7.2 Safety-specific characteristic values for DG..C

For SIL	
Suitable for Safety Integrity Level	SIL 1, 2, 3
Diagnostic coverage DC	0
Type of subsystem	Type A to EN 61508-2, 7.4.3.1.2
Mode of operation	High demand mode pursuant to EN 61508-4:2001, 3.5.12
For PL	
Suitable for Performance Level	PL a, b, c, d, e
Category	B, 1, 2, 3, 4
Common cause failure CCF	> 65
Application of essential safety requirements	Satisfied
Application of tried-and-tested safety requirements	Satisfied
For SIL and PL	
	B _{10d} value
U = 24 V DC, I = 10 mA; U = 230 V AC, I = 4 mA	6,689,477 operating cycles
U = 24 V DC, I = 70 mA; U = 230 V AC, I = 20 mA	4,414,062 operating cycles
U = 230 V AC, I = 2 A	974,800 operating cycles
Hardware fault tolerance (1 component/switch) HFT	0
Hardware fault tolerance (2 components/switches, redundant operation) HFT	1
Safe failure fraction SFF	> 90%
Fraction of undetected common cause failures β	≥ 2%

Max. service life under operating conditions:
10 years after date of production, plus max. 1/2 year in stor-

age prior to first use, or once the given number of operating cycles has been reached, depending on which is achieved first.

The pressure switches are suitable for single-channel systems (HFT = 0) up to SIL 2/PL d, and up to SIL 3/PL e when two redundant pressure switches are installed in a double-channel architecture (HFT = 1), provided that the complete system complies with the requirements of EN 61508/ISO 13849.

For a glossary of terms, see page 20 (Glossary).

Determining the PFH_D value, the λ_D value and the MTTF_d value

$$PFH_D = \lambda_D = \frac{1}{MTTF_d} = \frac{0,1}{B_{10d}} \times n_{op}$$

7.3 Dimensions

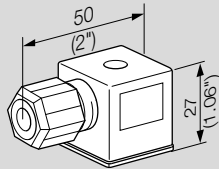

Socket for DG..C

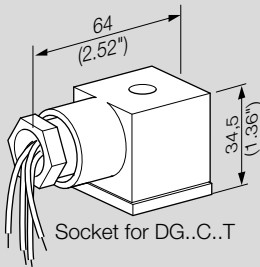

Socket for DG..C..T

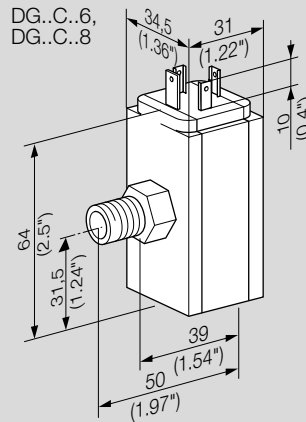

DG..C..6,
DG..C..8

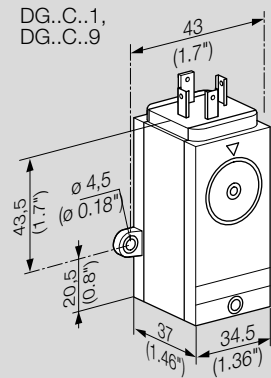

DG..C..1,
DG..C..9

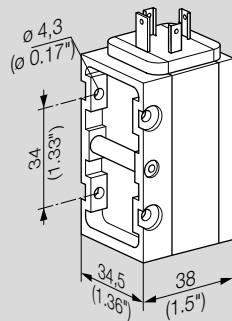

DG..C..3

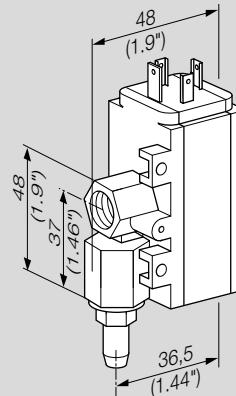

DG..C..4

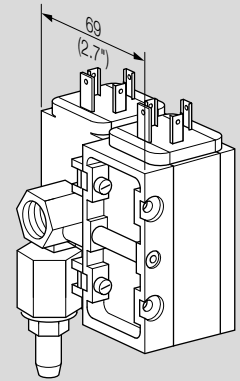

DG../..C..4

7.4 Converting units

See www.adlatus.org

8 Maintenance cycles

We recommend a function check once a year.

9 Glossary

9.1 Diagnostic coverage DC

Measure of the effectiveness of diagnostics, which may be determined as the ratio between the failure rate of detected dangerous failures and the failure rate of total dangerous failures

NOTE: Diagnostic coverage can exist for the whole or parts of a safety-related system. For example, diagnostic coverage could exist for sensors and/or logic system and/or final elements. Unit: %

see EN ISO 13849-1

9.2 Mode of operation

High demand mode or continuous mode

Operating mode, where the frequency of demands for operation made on a safety-related system is greater than one per year or greater than twice the proof-test frequency

see EN 61508-4

9.3 Category

Classification of the safety-related parts of a control system in respect of their resistance to faults and their subsequent behaviour in the fault condition, and which is achieved by the structural arrangement of the parts, fault detection and/or by their reliability

see EN ISO 13849-1

9.4 Common cause failure CCF

Failures of different items, resulting from a single event, where these failures are not consequences of each other

see EN ISO 13849-1

9.5 Fraction of undetected common cause failures β

Fraction of undetected failures of redundant components due to a single event, whereby these failures are not based on mutual causes

NOTE: β is expressed as a fraction in the equations and as a percentage elsewhere.

see EN 61508-6

9.6 B_{10d} value

Mean number of cycles until 10% of the components fail dangerously

see EN ISO 13849-1

9.7 T_{10d} value

Mean time until 10% of the components fail dangerously

see EN ISO 13849-1

9.8 Hardware fault tolerance HFT

A hardware fault tolerance of N means that N + 1 is the minimum number of faults that could cause a loss of the safety function

see IEC 61508-2

9.9 Mean dangerous failure rate λ_D

Mean rate of dangerous failures during operation time (T_{10d}). Unit: 1/h

see EN ISO 13849-1

9.10 Safe failure fraction SFF

Fraction of safe failures related to all failures, which are assumed to appear

see EN 13611/A2

9.11 Probability of dangerous failure PFH_D

Value describing the likelihood of dangerous failure per hour of a component for high demand mode or continuous mode. Unit: 1/h

see EN 13611/A2

9.12 Mean time to dangerous failure MTTF_D

Expectation of the mean time to dangerous failure

see EN ISO 13849-1:2008

9.13 Demand rate n_{Op}

Mean number of annual operations

see EN ISO 13849-1

9.14 Average probability of dangerous failure on demand PFD_{avg}

(LDM = 1 – 10 switching cycles/year)

Average probability of a dangerous failure of the safety function on demand (LDM = low demand mode)

see EN 61508-6

Fore more information

The Honeywell Thermal Solutions family of products includes Honeywell Combustion Safety, Eclipse, Exothermics, Hauck, Kromschroder and Maxon. To learn more about our products, visit ThermalSolutions.honeywell.com or contact your Honeywell Sales Engineer.

Elster GmbH
Strotheweg 1, D-49504 Lotte
T +49 541 1214-0
hts.lotte@honeywell.com
www.kromschroeder.com

© 2019 Elster GmbH

We reserve the right to make technical modifications in the interests of progress.

