

Pressure switches for gas DG

TECHNICAL INFORMATION

- Monitoring of gas and air pressures (positive, negative and differential pressures)
- Certified for systems up to SIL 3 and PL e
- With approved isolating amplifier for Zone 1 and 2 hazardous areas
- EU certified pursuant to EN 1854 and class “S”
- DG..S: special version available for NH₃ and O₂



Contents

Contents	2	4 Selection	16
1 Application	3	4.1 ProFi	16
1.1 DG	5	4.2 DG selection table	16
1.2 DG..T	5	4.2.1 Type code	17
1.3 Application examples	6	4.2.2 Mechanical connection	17
1.3.1 Low gas pressure monitoring	6	4.3 DG..T selection table	18
1.3.2 Differential pressure monitoring	6	4.3.1 Type code	18
1.3.3 Systems leak tightness check	6	4.3.2 Mechanical connection	19
1.3.4 Negative pressure monitoring	6	5 Project planning information	20
1.3.5 Air line with minimum pressure and flow monitoring	7	5.1 Installation position	20
1.3.6 Low and high gas pressure protection	7	5.2 Installation	20
2 Certification	8	5.2.1 Pressure monitoring at high temperatures	21
2.1 Overview of product approvals	9	5.3 Mechanical connection	22
3 Function	10	5.3.1 DG	22
3.1 Vent limiter	10	5.3.2 DG..T	23
3.2 Positive pressure measurement	11	5.4 Resetting pressure switches with manual reset	23
3.3 Negative pressure measurement	11	6 Accessories	24
3.4 Differential pressure measurement	11	6.1 Fastening set with screws, U-shape bracket	24
3.5 Connection diagrams	12	6.2 Connecting set	24
3.5.1 Contact position	12	6.3 External adjustment	24
3.5.2 Blue pilot lamp for 230 V AC or 110/120 V AC	12	6.4 Pressure equalization element	25
3.5.3 Pilot lamp with plug	12	6.5 Restrictor orifice	25
3.5.4 Red/green pilot LED for 24 V DC/AC or 110–230 V AC	12	6.6 Test key PIA	25
3.5.5 Pilot LED with plug	12	6.7 Filter pad set	25
3.6 Wiring	13	6.8 Tube set	25
3.6.1 DG 1,5l, DG 12l	13	6.9 Standard coupler plug set	26
3.7 DG in Zone 1 (21) and 2 (22) hazardous areas	14	6.10 Pilot lamp set, red or blue	26
3.7.1 Intrinsically safe circuit without monitoring for cable faults	14	6.11 LED set, red/green	26
3.7.2 Intrinsically safe circuit with monitoring for cable discontinuities	14	6.12 Weather protection cover	27
3.7.3 Intrinsically safe circuit with monitoring for cable faults and short-circuits	14		
3.8 DG in Zone 2 (22) hazardous areas	15		

7 Technical data	28
7.1 Ambient conditions	28
7.2 Mechanical data	28
7.2.1 Recommended tightening torque	28
7.3 Electrical data	29
7.4 DG adjusting range and switching hysteresis	30
7.5 DG..T adjusting range and switching hysteresis	32
8 Dimensions	33
9 Converting units	34
10 Safety-specific characteristic values for SIL and PL	35
10.1 Determining the PFH _D value, λ _D value and MTTF _d value	35
10.2 Designed lifetime	36
10.3 Use in safety-related systems	36
11 Safety information in accordance with EN 61508-2	37
11.1 Scope of application	37
11.2 Product description	37
11.3 Reference documents	37
11.4 Applicable standards	37
11.5 Safety function	37
11.6 Safety instructions concerning operating limits	37
11.7 Installation and commissioning	37
11.8 Operation and maintenance	37
11.9 Troubleshooting	37
11.9.1 Repairs	37
11.10 Safety instructions concerning design verification	37
11.11 Characteristic safety data/SIL capability	38
11.12 Mode of operation	38
12 Operation and maintenance	39
12.1 Tightness test	39
12.2 Function test on installed pressure switches	39

12.2.1 Checking the switching point by measuring the process variable which is critical for safety	39
12.2.2 Checking the switching point by measuring when installed	40
12.2.3 Checking the switching point or function check by rotating the hand wheel	43
12.3 Accuracy of the tests	45
12.3.1 Examples for calculating the switch-on point when a switch-off point of x mbar is required	47
13 Maintenance cycles	48
14 Glossary	49
14.1 Diagnostic coverage DC	49
14.2 Mode of operation	49
14.3 Category	49
14.4 Common cause failure CCF	49
14.5 Fraction of undetected common cause failures β	49
14.6 B _{10d} value	49
14.7 T _{10d} value	49
14.8 Hardware fault tolerance HFT	49
14.9 Mean dangerous failure rate λ _D	50
14.10 Safe failure fraction SFF	50
14.11 Probability of dangerous failure PFH _D	50
14.12 Mean time to dangerous failure MTTF _d	50
14.13 Demand rate n _{op}	50
14.14 Average probability of dangerous failure on demand PFD _{avg}	50
For more information	51

1 Application



DG, adjustable switching point



DG..H, DG..N, adjustable switching point. Locks off once the switching point is reached. Manual reset.



DG..-6, with fitted socket pursuant to DIN EN 175301-803



DG..T, hand wheel with "WC and mbar scale. ½ NPT conduit for electrical connection.

The gas pressure switch DG monitors extremely low pressure differentials and triggers switch-on, switch-off or switch-over operations if a set switching point is reached. The switching point can be adjusted using a hand wheel.

It monitors positive and negative gas pressures on various industrial gas and air appliances, such as boiler fan moni-

Application

toring and differential pressure monitoring in firing, ventilation and air-conditioning systems.

Pressure switches with manual reset lock off after switching.

Pressure switches (DG..T) with UL, FM approval are fitted with a nozzle to limit the flow rate, see page 12 (Vent limiter).

The TÜV-tested special-design pressure switch is used as defined by VdTÜV Code of Practice "Druck 100/1" (Pressure 100/1) in firing installations for steam and hot-water generators in accordance with TRD 604, Para. 3.6.4, as well as class "S" for DG..B, DG..U and DG..I pursuant to EN 1854.

1.1 DG

Type	Hand wheel setting/Switching properties	Positive pressure	Negative pressure
DG..B	Hand wheel set to rising pressure/ DG switches with rising and falling pressure	Gas, air, flue gas or biogas	–
DG..U	Hand wheel set to rising pressure/ DG switches with rising and falling pressure	Gas, air, flue gas or biogas	Air, flue gas
DG..BN	Hand wheel set to falling pressure/ DG switches with rising and falling pressure	Gas, air, flue gas or biogas	–
DG..UN	Hand wheel set to falling pressure/ DG switches with rising and falling pressure	Gas, air, flue gas or biogas	Air, flue gas
DG..I	Hand wheel set to rising pressure/ DG switches with rising and falling pressure	Gas, air, flue gas	Gas, air, flue gas or biogas
DG..S	Hand wheel set to rising pressure/ DG switches with rising and falling pressure	NH ₃ , O ₂ , air	–
DG..H	Hand wheel set to rising pressure/ DG switches with rising pressure and locks off	Gas, air, flue gas or biogas	Air, flue gas
DG..N	Hand wheel set to falling pressure/ DG switches with falling pressure and locks off	Gas, air, flue gas or biogas	Air, flue gas

Electrical connection: screw terminals and M16 cable gland or plug with socket.

1.2 DG..T

Type	Hand wheel setting/Switching properties	Positive pressure	Negative pressure
DG..T	Hand wheel set to rising pressure/ DG switches with rising and falling pressure	Gas, air, flue gas or biogas	Air, flue gas
DG..FT	Hand wheel set to falling pressure/ DG switches with rising and falling pressure	Gas, air, flue gas or biogas	Air, flue gas
DG..HT	Hand wheel set to rising pressure/ DG switches with rising pressure and locks off	Gas, air, flue gas or biogas	Air, flue gas
DG..NT	Hand wheel set to falling pressure/ DG switches with falling pressure and locks off	Gas, air, flue gas or biogas	Air, flue gas
DG..ST	Hand wheel set to rising pressure/ DG switches with rising and falling pressure	NH ₃ , O ₂ , air	–

Electrical connection: screw terminals and M16 cable gland or screw terminals and ½ NPT conduit or plug with socket.

1.3 Application examples

1.3.1 Low gas pressure monitoring

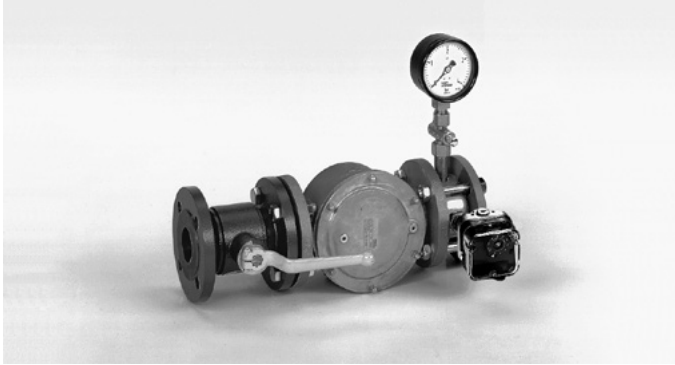

For monitoring the minimum gas inlet pressure

1.3.2 Differential pressure monitoring

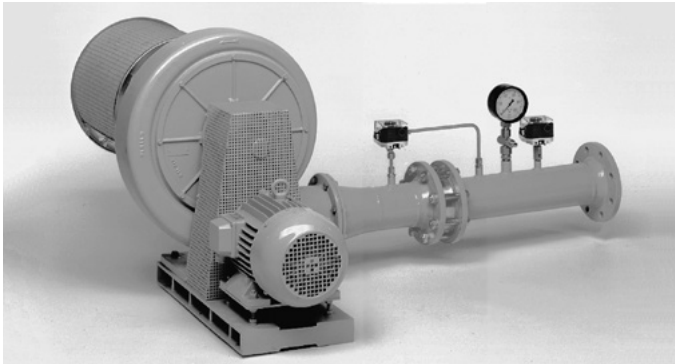

Differential pressure switch for monitoring air filters

1.3.3 Systems leak tightness check

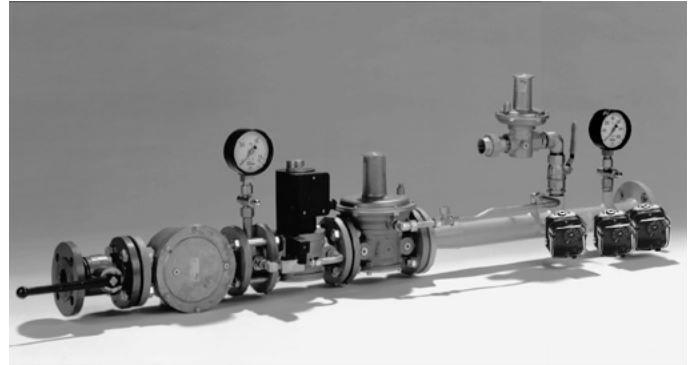

Electronic safety shut-off valve SSV with leak tightness check of downstream devices

1.3.4 Negative pressure monitoring



Monitoring the negative pressure ensures the correct positioning of the components during fully automatic assembly of gas meters.

1.3.5 Air line with minimum pressure and flow monitoring

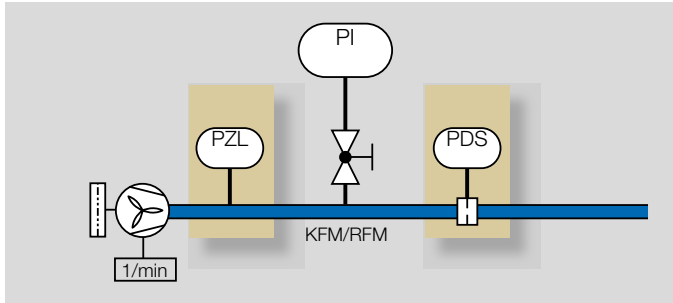

The air flow generated by the fan may be monitored as follows:

The static pressure is monitored by the pressure switch (PZL) as long as it can be demonstrated that the display consequently shows an adequate and secured flow of air, or the pressure switch (PDS) checks the flow of air via the differential pressure on the orifice.

If there is no air pressure supplied or if there is no differential pressure on the orifice, the system will be blocked.

1.3.6 Low and high gas pressure protection

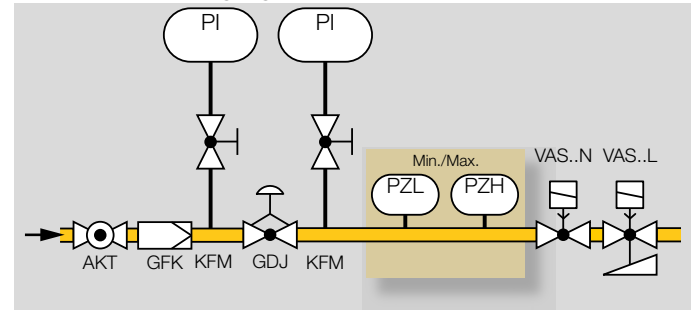

If the pressure is either too low or too high, the min./max. pressure switch (PZL/PZH) switches in order to avoid start-up or to initiate a safety shut-down.

2 Certification

Certificates – see www.docuthek.com

Certified to SIL and PL



For systems up to SIL 3 pursuant to EN 61508 and PL e pursuant to ISO 13849. See page 37 (Safety-specific characteristic values for SIL and PL).

EU certified



- 2014/35/EU (LVD), Low Voltage Directive
- 2014/30/EU (EMC), Electromagnetic Compatibility Directive
- 2011/65/EU, RoHS II
- 2015/863/EU, RoHS III
- (EU) 2016/426 (GAR), Gas Appliances Regulation
- EN 1854:2010

DG..T: FM approved*



Factory Mutual Research Class: 3510 Flow and pressure safety switches. Designed for applications pursuant to NFPA 85 and NFPA 86. www.approvalguide.com

DG..T: UL listed*

USA and Canada



Underwriters Laboratories – UL 353 “Limit Controls”. www.ul.com

AGA approved*



Australian Gas Association, Approval No.: 5484. www.aga.asn.au









Eurasian Customs Union*



The product DG meets the technical specifications of the Eurasian Customs Union.

** Approval does not apply to DG..S. DG..S complies with the requirements of the Low Voltage Directive 2014/35/EU (LVD).*

2.1 Overview of product approvals

DG..B, DG..U, DG..H, DG..N, DG..I	DG..T, DG..HT, DG..NT	DG..S
	-	-
	-	
	-	-
	-	-
	-	-
-		-
-		-

3 Function

The pressure switch switches with rising or falling pressure. Once the set switching point is reached, a micro switch is activated in the DG which is designed as a change-over contact.

The switching pressure is adjusted using a hand wheel.

Pressure switches which lock off after switching can only be unlocked with a manual reset, see page 25 (Resetting pressure switches with manual reset).

DG

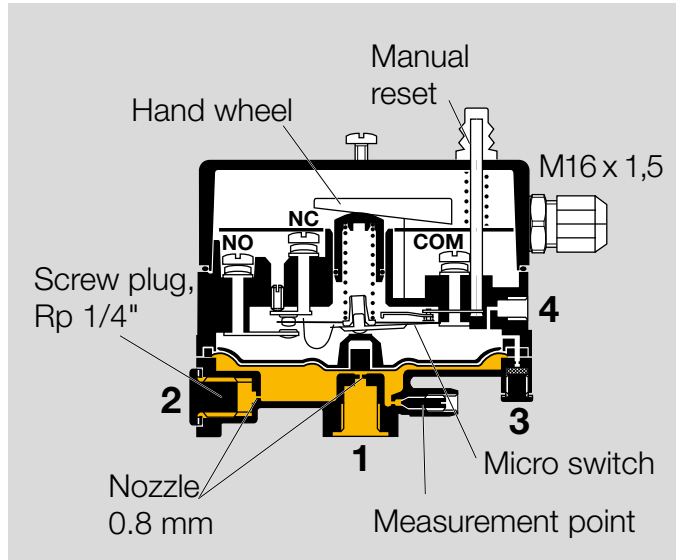

DG..T

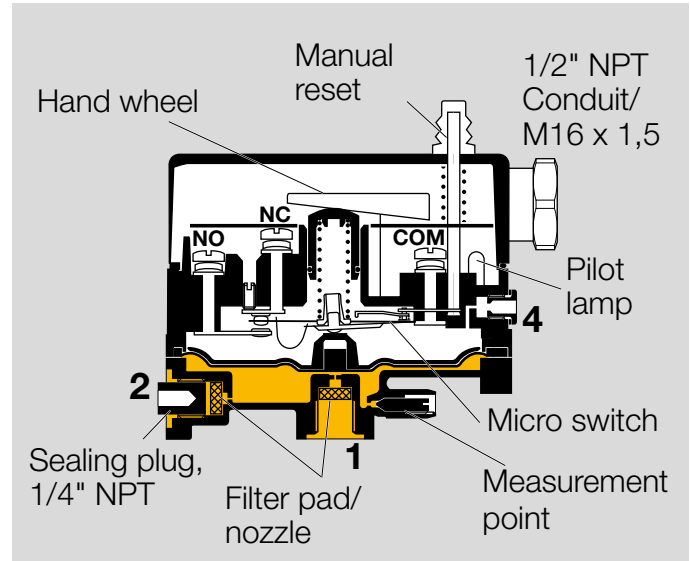

3.1 Vent limiter

The flow on pressure switches DG 6..T to DG 500..T is limited by the nozzle. In the event of a diaphragm tear, the escape of gas is limited to less than 1.0 CFH of natural gas, see max. inlet pressure, see page 30 (Technical data).

3.2 Positive pressure measurement

Positive pressure measurement is designed, for example, for checking the fan function or measuring the min./max. pressure.

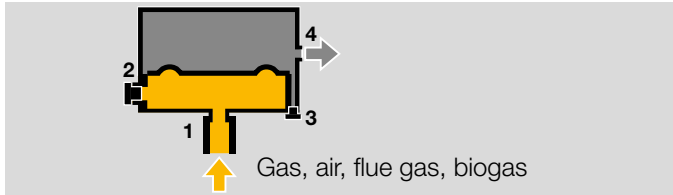

The positive pressure is measured in the lower diaphragm chamber, port **1** (or **2**). The upper diaphragm chamber is ventilated via port **4** (or **3**).

3.3 Negative pressure measurement

Negative pressure measurement (air, flue gas) is designed, for example, for monitoring a suction pressure blower.

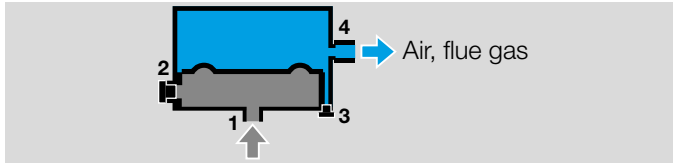

The negative pressure is measured in the upper diaphragm chamber, port **4** (or **3**). The lower diaphragm chamber is ventilated via port **1** (or **2**).

In the case of DG..I, the negative pressure (gas, air, flue gas or biogas) is measured in the lower diaphragm chamber, port **1** or **2**. The upper diaphragm chamber is ventilated via port **4** or **3**.

3.4 Differential pressure measurement

Differential pressure measurement is designed for safeguarding an air flow rate or for monitoring filters and fans, for example.

Do not connect port **4** (or **3**) to pipes carrying gas! For further information, see "Project planning information", "Mechanical connection", page 24 (DG).

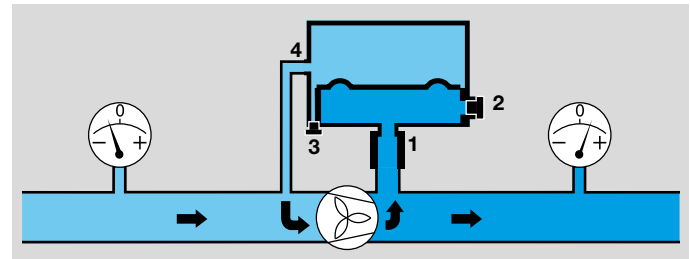
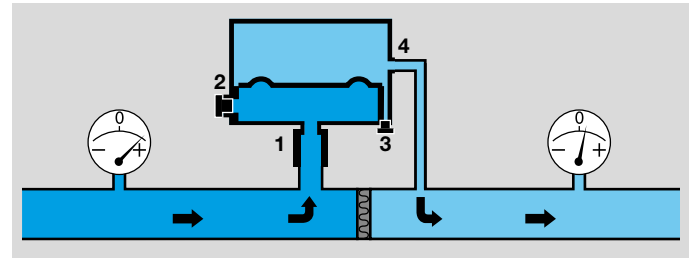

The higher absolute pressure is connected to port **1** (or **2**), and the lower absolute pressure to port **4** (or **3**). The remaining ports must be tightly plugged.

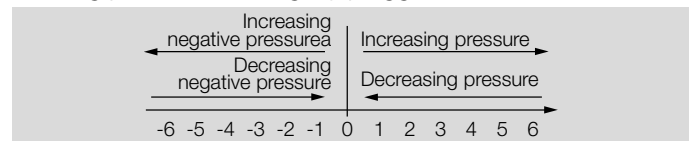

3.5 Connection diagrams

3.5.1 Contact position

Contacts 3 and 2 close when subject to increasing pressure.

Contacts 1 and 3 close when subject to falling pressure.

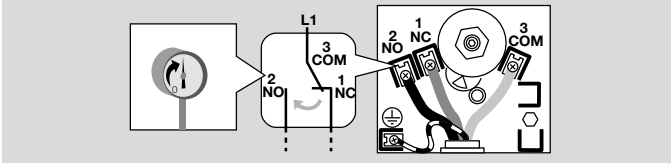

On pressure switches that switch with rising pressure:
The contact switches from NC 1 to NO 2.

On pressure switches that switch with falling pressure:
The contact switches from NO 2 to NC 1.

3.5.2 Blue pilot lamp for 230 V AC or 110/120 V AC

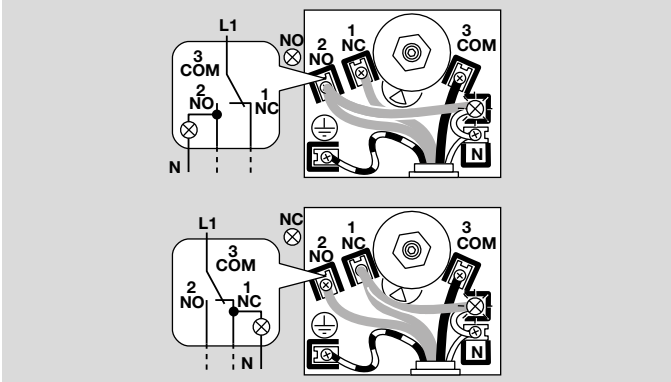

3.5.3 Pilot lamp with plug

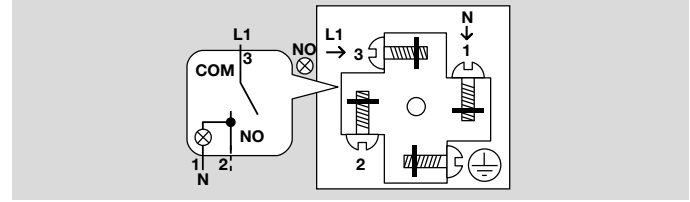

3.5.4 Red/green pilot LED for 24 V DC/AC or 110–230 V AC

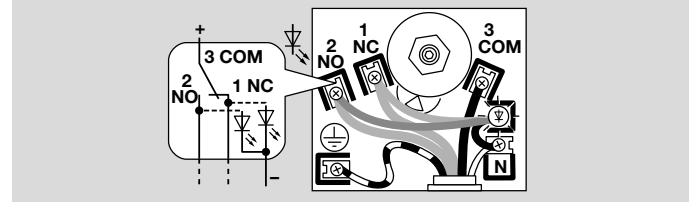

3.5.5 Pilot LED with plug

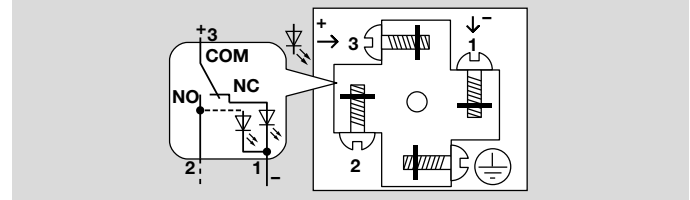

3.6 Wiring

If the DG..G has switched a voltage $> 24\text{ V}$ ($> 30\text{ V}$) and a current $> 0.1\text{ A}$ at $\cos \varphi = 1$ or $> 0.05\text{ A}$ at $\cos \varphi = 0.6$ once, the gold plating on the contacts will have been burnt through. It can then only be operated at this power rating or higher power rating.

When using silicone tubes, only use silicone tubes which have been sufficiently cured. Vapours containing silicone can adversely affect the functioning of electrical contacts.

In the case of low switching capacities, such as 24 V , 8 mA , for example, we recommend using an RC module ($22\ \Omega$, $1\ \mu\text{F}$) in air containing silicone or oil.

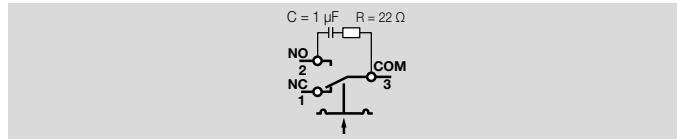

In the case of high humidity or aggressive gas components (H_2S), we recommend using a pressure switch with gold contact due to its higher resistance to corrosion. Closed-circuit current monitoring is recommended under difficult operating conditions.

All DG models (except DG..I)

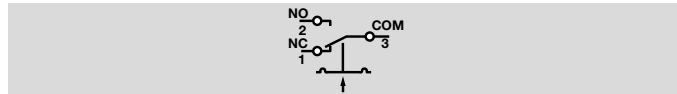

Contacts 3 and 2 close when subject to increasing pressure. Contacts 1 and 3 close when subject to falling pressure.

DG 18I, DG 120I, DG 450I

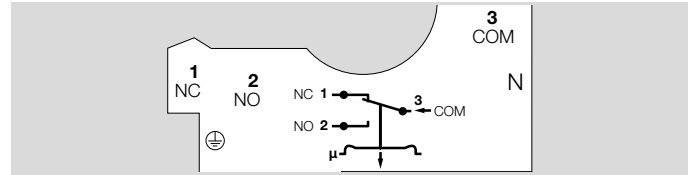

Contacts 3 and 2 close when subject to increasing negative pressure. Contacts 1 and 3 close when subject to falling negative pressure.

3.6.1 DG 1,5I, DG 12I

The connection of DG 1,5I, DG 12I depends on the positive or negative adjusting range.

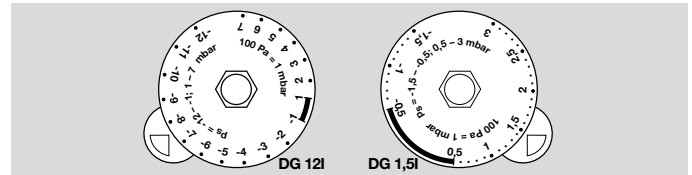

In the negative adjusting range, the template which can be found in the unit displays the connection diagram.

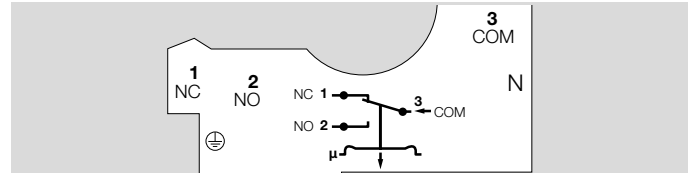

In the positive adjusting range, remove the template and wire the unit as shown in the engraved connection diagram.

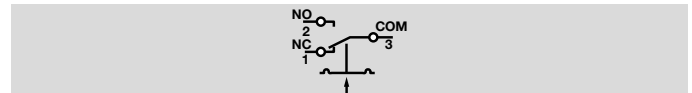

3.7 DG in Zone 1 (21) and 2 (22) hazardous areas

Pressure switch DG can be used in Zone 1 (21) and 2 (22) hazardous areas if an isolating amplifier is installed upstream in the safe area as “Ex-i” apparatus pursuant to EN 60079-11 (VDE 0170-7):2012.

DG as “simple electrical equipment” pursuant to EN 60079-11:2012 corresponds to the Temperature class T6, Group II. The internal inductance/capacitance is $L_i = 0.2 \mu\text{H}/C_i = 8 \text{ pF}$.

The isolating amplifier transfers the DG’s signals from the explosion-hazard area to the safe area. Depending on the design of the intrinsically safe circuit, the explosion-hazard area can be monitored for cable faults, cable discontinuities or short-circuits.

Ensure that standard-compliant wiring pursuant to EN 60079 is used.

When operating in Zones 21 and 22, the 1/8" connecting thread or the tube connection for the surrounding air or medium connection must be protected from dirt particles by a separate filter.

3.7.1 Intrinsically safe circuit without monitoring for cable faults

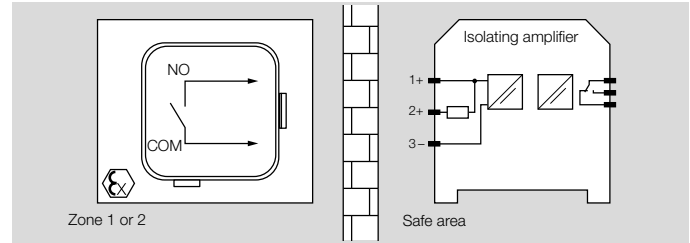

3.7.2 Intrinsically safe circuit with monitoring for cable discontinuities

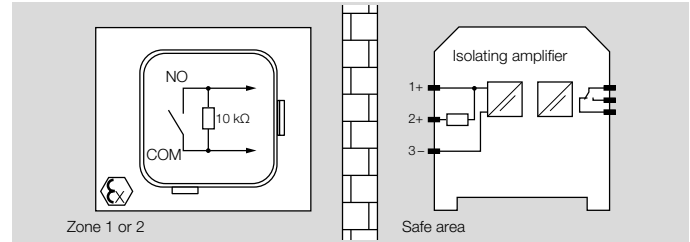

3.7.3 Intrinsically safe circuit with monitoring for cable faults and short-circuits

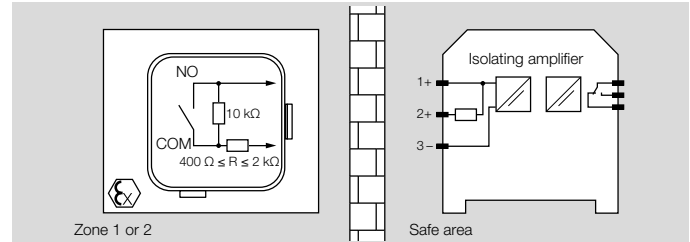

3.8 DG in Zone 2 (22) hazardous areas

Pressure switch DG can be connected to pipes/rooms in which Zone 2 (22) explosive gases or dust are present without an isolating amplifier.

The connection to Zone 2, Zone 22 must be implemented via one of the two ¼" threads. Even in the unlikely event of a break in the diaphragm, there is no danger of flashback into the system. The pressure compensation holes on the pressure switch (1/4" connections) have a defined ignition protection, in terms of the safety measure for "enclosed break devices for Group IIA gases and vapours", pursuant to IEC/EN 60079-15.

In the case of Zone 22, it must be ensured that dirt particles do not block the pressure supply hole ($\varnothing = 0.8 \text{ mm}$).

4 Selection

4.1 ProFi

A web app selecting the correct product is available at www.adlatus.org.

4.2 DG selection table

Option	DG..B, DG..BN, DG..U, DG..UN	DG..H, DG..N	DG..S	DG..I
Adjusting range [mbar]	6, 10, 30, 50, 150, 400, 500	10, 50, 150, 500	6, 10, 30, 50, 150, 400, 450	-1.5; -12; -18; -120; -450
Hand wheel set to rising pressure	DG..U, DG..B	DG..H	DG..S	DG..I
Hand wheel set to falling pressure	DG..BN, DG..UN	DG..N	-	-
Lock-off	-	DG..H, DG..N	-	-
With gold-plated contacts	DG..B, DG..BN, DG..U, DG..UN	DG..H, DG..N	DG..S	DG..I
Electrical connection	-3, -4, -5, -6, -9	-3, -4, -5, -6, -9	-3, -4, -5, -6, -9	-3, -4, -5, -6, -9
Pilot lamp	K2, T, T2, N	K2, T, T2, N	K2, T, T2, N	K2, T, T2, N
External adjustment	DG..B, DG..BN, DG..U, DG..UN	DG..H, DG..N	DG..S	DG..I

Order example

DG 10U-3

Adjusting range and switching hysteresis, see page 30 (Technical data).

4.2.1 Type code

DG	Pressure switch for gas
1,5	Negative pressure adjusting range -1.5 – -0.5/+0.5 – +3 mbar
6	Adjusting range 0.4 – 6 mbar
10	Adjusting range 1 – 10 mbar
12	Negative pressure adjusting range -12 – -1/+1 – +7 mbar
18	Negative pressure adjusting range -2 – -18 mbar
30	Adjusting range 2.5 – 30 mbar
50	Adjusting range 2.5 – 50 mbar
120	Negative pressure adjusting range -10 – -120 mbar
150	Adjusting range 30 – 150 mbar
400	Adjusting range 50 – 400 mbar
450	Negative pressure adjusting range -80 – -450 mbar
500	Adjusting range 100 – 500 mbar
B	Switches with rising positive pressure
BN	Switches with falling positive pressure
U	Switches with rising positive pressure (gas/air), negative pressure (air), differential pressure (air-air)
UN	Switches with falling positive pressure (gas/air), negative pressure (air), differential pressure (air-air)
H	Switches and locks off with rising pressure
N	Switches and locks off with falling pressure
I	Negative pressure for gas
S	Positive pressure for oxygen and ammonia
G	With gold-plated contacts
-3	Electrical connection via screw terminals
-4	Electrical connection via screw terminals, IP 65

-5	Electrical connection via 4-pin plug, without socket, IP 54
-6	Electrical connection via 4-pin plug, with socket, IP 54
-9	Electrical connection via 4-pin plug, with socket, IP 65
K2	Red/green pilot LED for 24 V DC/AC
T	Blue pilot lamp for 230 V AC
T2	Red/green pilot LED for 110 to 230 V AC
N	Blue pilot lamp for 120 V AC
A	External adjustment
10–60	Bulk packaging
Z	Special version

4.2.2 Mechanical connection

DG..U, DG..H, DG..N, DG..I:

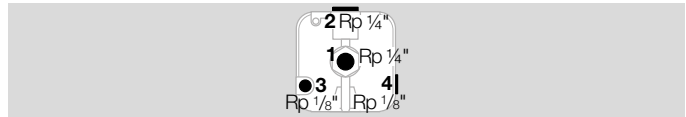

Ports 1 and 2: Rp 1/4" (standard),
Ports 3 and 4: Rp 1/8" (standard).

DG..B, DG..S:

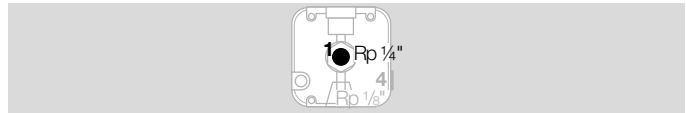

Port 1: Rp 1/4" (standard).

4.3 DG..T selection table

Option	DG..T, DG..ST	DG..FT	DG..HT	DG..NT
Adjusting range 6–500	6, 10, 50, 150, 500	6, 10, 50, 150, 500	6, 10, 50, 150, 500	6, 10, 50, 150, 500
Hand wheel set to rising pressure	DG..T, DG.. ST	–	DG..HT	–
Hand wheel set to falling pressure	–	DG..FT	–	DG..NT
Lock-off	–	–	DG..HT	DG..NT
With gold-plated contacts	DG..T, DG.. ST	DG..FT	DG..HT	DG..NT
Electrical connection	-2, -4, -9	-2, -4, -9	-2, -4, -9	-2, -4, -9
Pilot lamp	K2, T2, N	K2, T2, N	K2, T2, N	K2, T2, N
External adjustment	DG..T, DG.. ST	DG..FT	DG..HT	DG..NT

Adjusting range and switching hysteresis, see page 30 (Technical data).

4.3.1 Type code

DG	Pressure switch for gas
6	Adjusting range 0.2–2.4 “WC (0.5-6 mbar)
10	Adjusting range 0.4–4 “WC (1-10 mbar)
50	Adjusting range 1–20 “WC (2.5-50 mbar)
150	Adjusting range 12–60 “WC (30-150 mbar)
500	Adjusting range 40–200 “WC (100-500 mbar)
H	Switches and locks off with rising pressure
N	Switches and locks off with falling pressure
F	Switches with falling positive pressure
S	Switches with rising and falling positive pressure; for O ₂ , NH ₃ and air; without approval
T	T-product
G	With gold-plated contacts
-2	Electrical connection via screw terminals, 1/2" NPT Conduit, NEMA 4 (IP 65)
-4	Electrical connection via screw terminals, cable gland, NEMA 4 (IP 65)
-9	Electrical connection via 4-pin plug, with socket, NEMA 4 (IP 65)
1	NPT connection 1x 1/4"
2	NPT connection 2x 1/4"
N	Blue pilot lamp for 120 V AC
T2	Red/green pilot LED for 110 to 230 V AC
K2	Red/green pilot LED for 24 V DC/AC
A	External adjustment

¹⁾ Letter omitted = DG..T switches with rising pressure

4.3.2 Mechanical connection

DG..T:

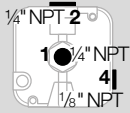







Port 1: 1/4" NPT (standard) or
ports 1 and 2: 1/4" NPT (DG..T..2 available),
port 4: 1/8" NPT (standard).

5 Project planning information

5.1 Installation position

Installation in the vertical or horizontal position, or sometimes upside down, preferably with vertical diaphragm. If installed in a vertical position, the switching point p_S will correspond to the scale value SK set on the hand wheel. If installed in another position, the switching point p_S will change and no longer correspond to the set scale value SK. Switching point p_S must be checked.

		
All DG models (except DG..I)		
$p_S = SK$	$p_S = SK + 0.18 \text{ mbar (0.8 "WC)}$	$p_S = SK - 0.18 \text{ mbar (0.8 "WC)}$
DG 1,5I		
$p_S = SK$	$p_S = SK + 0.4 \text{ mbar}$ e.g. SK = 1.2: $p_S = 1.2 + 0.4 = 1.6 \text{ mbar}$ e.g. SK = -1.2: $p_S = -1.2 + 0.4 = -0.8 \text{ mbar}$	
DG 12I		
$p_S = SK$	$p_S = SK + 0.5 \text{ mbar}$ e.g. SK = 5: $p_S = 5 + 0.5 = 5.5 \text{ mbar}$ e.g. SK = -10: $p_S = -10 + 0.5 = -9.5 \text{ mbar}$	
DG 18I, DG 120I, DG 450I		
$p_S = SK$	DG 18I: $p_S = SK + 0.5 \text{ mbar}$ e.g. SK = -10: $p_S = -10 + 0.5 = -9.5 \text{ mbar}$ DG 120I, DG 450I: $p_S = SK + 0.2 \text{ mbar}$	

5.2 Installation

The housing must not be in contact with masonry. Minimum clearance 20 mm (0.8").

The DG..S is suitable for oxygen and ammonia only (diaphragm made of IIR). Do not use for fuel gases – diaphragm not resistant! In the case of oxygen, ensure grease-free installation.

Long-term use in the upper ambient temperature range accelerates the ageing of the elastomer materials and reduces the service life (please contact manufacturer).

Continuous operation with gases containing more than 0.1 %-by-vol. H₂S or ozone concentrations exceeding 200 µg/m³ accelerate the ageing of elastomer materials and reduce the service life.

Vapours containing silicone can adversely affect the functioning of electrical contacts. When using silicone tubes, only use silicone tubes which have been sufficiently cured.

Condensation must not be allowed to get into the housing. If possible, install pipework with an ascending gradient. Otherwise, there is a risk of icing of condensation at subzero temperatures, the switching point shifting or corrosion in the device which can lead to malfunctions.

Closed-circuit current monitoring is recommended if there is a risk of contact corrosion (too humid or aggressive surrounding air) or foreign particles in the surrounding air.

When installing outdoors, place the pressure switch in a roofed area and protect from direct sunlight (even IP 65 version). To avoid condensation, the cover with pressure equalization element can be used. See page 27 (Pressure equalization element).

The weather protection cover provides permanent protection when installed outdoors. See page 29 (Weather protection cover).

In case of highly fluctuating pressures, install a restrictor orifice. See page 27 (Restrictor orifice).

5.2.1 Pressure monitoring at high temperatures

If they are equipped with suitable supply lines, pressure switches are able to monitor pressures in flue gas lines at high temperatures. It is just necessary to ensure that the hot medium does not enter the switch during a switching operation.

For this, the switching volume of the pressure switch is to be observed.

Volume per switching operation:

DG 6–50U, B, H, N, DL 5–50A, K = max. 9.5 cm³,

DG 150–500U, B, H, N, DL 150A, K = max. 2.5 cm³.

Requirement on the supply line

The volume of the supply line must be at least 1.2 times greater than the switching volume to ensure that the hot medium does not flow directly into the switching chamber. This accelerates ageing of the diaphragm and possible contact corrosion.

If there is a risk of condensation forming, the supply line must be installed with an upward gradient towards the pressure switch. Small line diameters are preferable (ID = 5 mm) to ensure that the humidity can condense in the long line and flow back into the furnace/chimney.

In the case of high switching frequency (more than once per minute), the volume of the line should be double that of the switching operation. Otherwise, there is a risk that there

will not be enough time or volume available for cooling if the media from the hot furnace and the tube volume are mixed.

5.3 Mechanical connection

5.3.1 DG

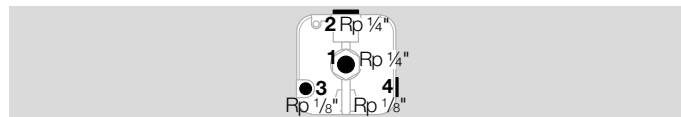

DG..U, DG..H, DG..N, DG..UN

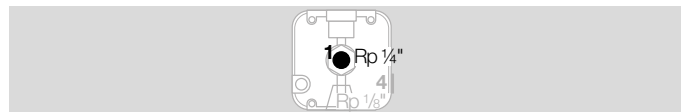

DG..B, DG..BN, DG..S

Positive pressure	Connect	Seal	Free*
DG..U, DG..H, DG..N, DG..UN	1	2	3 or 4
DG..U, DG..H, DG..N, DG..UN	2	1	3 or 4
DG..B, DG..BN, DG..S	1	–	4

Negative pressure	Connect	Seal	Free*
DG..U, DG..H, DG..N	4	3	1 or 2
DG..U, DG..H, DG..N	3	4	1 or 2
DG..I	1	2	3 or 4
DG..I	2	1	3 or 4

* It is recommended that the port which is best protected from water and dirt be left open.

Differential pressure	Connect		Seal
	for the higher absolute pressure	for the lower absolute pressure	
DG..U, DG..H, DG..N, DG..UN	1 or 2	3 or 4	Seal ports that are not in use

Ports **3** and **4** are connected to the micro switch chamber.

Pipes carrying gas must not be connected to port **3** or **4**!

The port that is best protected against soiling (dust/humidity) is to be left open for ventilation (positive pressure measurement) to the atmosphere. If dust exposure in the environment is high, a filter pad, see page 27 (Filter pad set), or a filter is to be used in the open port.

In the case of high switching frequency (more than once per minute), it is also recommended to use a filter pad since the exchange of air with the environment considerably increases the risk of foreign particles entering the pressure switch and thus a malfunction can occur at low voltages and currents.

5.3.2 DG..T



DG..T

Positive pressure	Connect	Seal	Free
DG..T	1	2	4
DG..T	2	1	4

Negative pressure	Connect	Seal	Free*
DG..T	4	–	1 or 2
DG..U, DG..H, DG..N	3	4	1 or 2*

* Port 2 only on DG..T..2 with 2 connections (1/4" NPT).

Differential pressure	Connect	
	for the higher absolute pressure	for the lower absolute pressure
DG..T	1 or 2	4

Port **4** is connected to the micro switch chamber.

For this reason, pipes carrying gas must not be connected to port **4**!

If necessary, port **4** (1/8" NPT) can be used to connect the venting line.

A filter pad at port **4** protects the electrical contacts in the pressure switch from dirt particles in the surrounding air or in the medium.

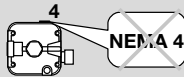

If port **4** is at the top, NEMA 4 (IP 65) will not be satisfied.

5.4 Resetting pressure switches with manual reset

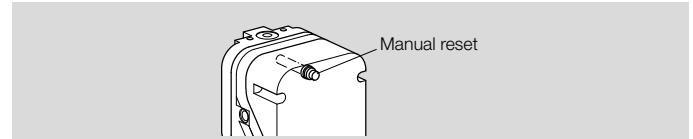

Pressure switches locking off if the pressure drops to the set switching point:

For resetting, the pressure must have risen to at least the set switching point **plus** the pressure differential between the switching pressure and possible reset.

Pressure switches locking off if the pressure rises to the set switching point:

For resetting, the pressure must have dropped to at least the set switching point **minus** the pressure differential between the switching pressure and possible reset.

Pressure differential, see page 32 (DG adjusting range and switching hysteresis).

6 Accessories

6.1 Fastening set with screws, U-shape bracket

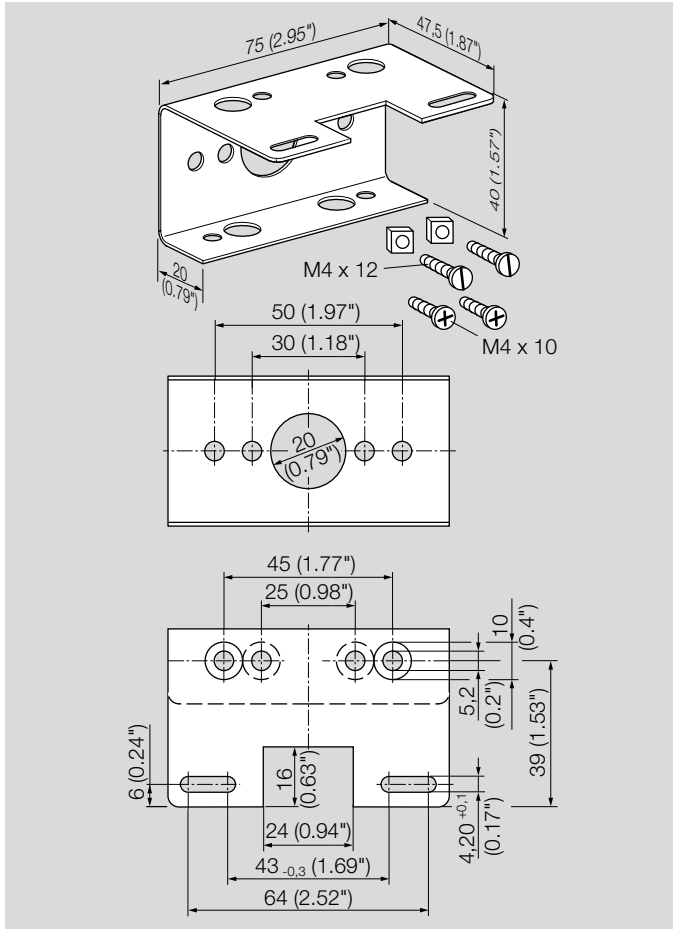

Order No.: 74915387

6.2 Connecting set

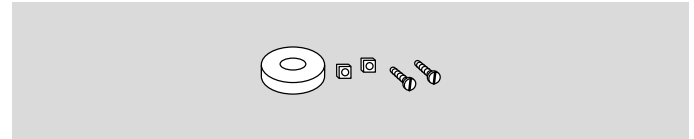

For monitoring a minimum and maximum inlet pressure with two pressure switches attached to one another.

Order No.: 74912250

6.3 External adjustment

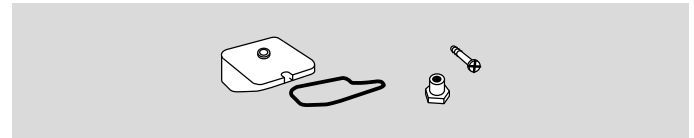

In order to set the switching pressure from the outside, the cover for external adjustment (6 mm Allen key) for DG can be retrofitted.

Order No.: 74916155

6.4 Pressure equalization element

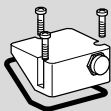

For CE certified pressure switches.

To avoid the formation of condensation, the cover with pressure equalization element can be used. The diaphragm in the screw connector is designed to ventilate the cover, without allowing water to enter.

Order No.: 74923391

6.5 Restrictor orifice

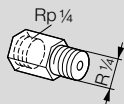

For CE certified pressure switches.

In the case of high pressure fluctuations, we recommend using a restrictor orifice (contains non-ferrous metals).

Hole diameter 0.2 mm, Order No.: 75456321

Hole diameter 0.3 mm, Order No.: 75441317

6.6 Test key PIA

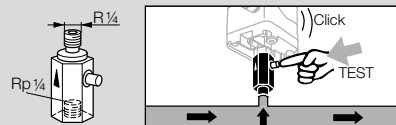

To test the min. pressure switch, the DG can be vented in its switched state using the PIA test key (contains non-ferrous metals).

Order No.: 74329466

6.7 Filter pad set

To protect the electrical contacts in the DG from dirt particles in the surrounding air or in the medium, use a filter pad at the 1/8" negative pressure port. As standard on IP 65 units.

5-piece filter pad set, Order No.: 74916199

6.8 Tube set

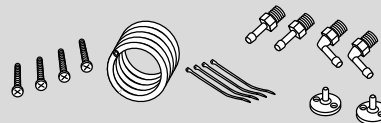

To be used with air only.

Tube set with 2 m PVC tube, 2 duct connection flanges with screws, R 1/4 and R 1/8 connecting nipples.

Order No.: 74912952

6.9 Standard coupler plug set



For CE certified pressure switches, Order No.: 74915388

For FM, UL certified pressure switches, Order No.:
75459526

6.10 Pilot lamp set, red or blue

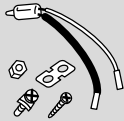

For DG

Pilot lamp, red:

110/120 V AC, I = 1.2 mA, Order No.: 74920430.

230 V AC, I = 0.6 mA, Order No.: 74920429.

Pilot lamp, blue:

110/120 V AC, I = 1.2 mA, Order No.: 74916121.

230 V AC, I = 0.6 mA, Order No.: 74916122.

6.11 LED set, red/green

For DG

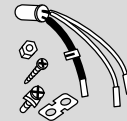

24 V DC, I = 16 mA; 24 V AC, I = 8 mA, Order No.:
74921089.

110 to 230 V AC, Order No.: 74923275

6.12 Weather protection cover

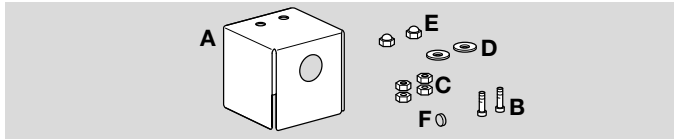

When the DG is installed outdoors, the weather protection cover provides permanent protection against condensation and weathering of housing parts.

The weather protection cover is made of 1 mm-thick stainless steel.

The enclosed filter pad is designed to protect the open 1/8" port from the ingress of dirt or insects.

Scope of delivery:

A 2 x covers, 100 x 100 x 100 mm

B 2 x M4 x 16 screws

C 4 x nuts

D 2 x washers

E 2 x cap nuts

F 1 x filter pad (1/8" port)

Order No.: 74924909

Installation position: vertical, with the cable gland pointing downwards.

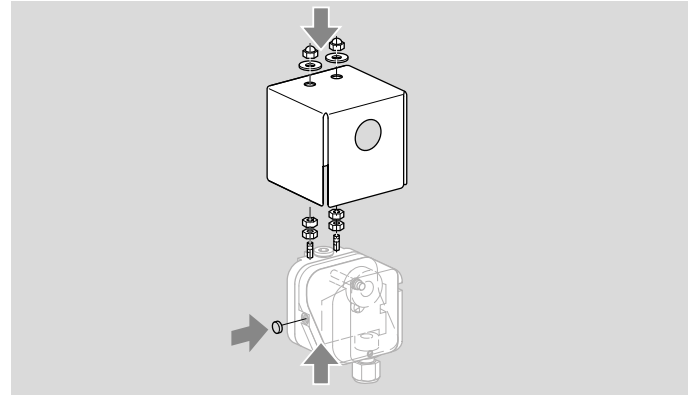

7 Technical data

7.1 Ambient conditions

Maximum medium and ambient temperatures:

DG..B, DG..U, DG..I: -20 to +80°C (-4 to +176°F),

DG..S, DG..ST: -15 to +60°C (5 to 140°F),

DG..H, DG..N: -15 to +60°C (5 to 140°F),

DG..T, DG..FT, DG..HT, DG..NT:

-40 to +60°C (-40 to +140°F).

Transport temperature = medium and ambient temperatures

Long-term use in the upper ambient temperature range accelerates the ageing of the elastomer materials and reduces the service life (please contact manufacturer).

The set switching point may palpably change in media and ambient temperatures below -22°F (-30°C).

Storage temperature:

DG, DG..T: -20 to +40°C (-4 to +104°F).

Enclosure:

DG: IP 54 or IP 65, safety class: 1.

DG..T: NEMA 4 (IP 65), safety class: 1.

7.2 Mechanical data

Gas type: natural gas, town gas, LPG (gaseous), flue gas, biogas (max. 0.1 %-by-vol. H₂S) and air.

Max. inlet pressure $p_{max.}$ = withstand pressure.. See page 32 (DG adjusting range and switching hysteresis).

Max. test pressure for testing the entire system: temporarily < 15 minutes 2 bar (29 psig).

Housing: glass fibre reinforced PBT plastic with low gas release.

Diaphragm pressure switch, silicone-free.

Diaphragm: NBR.

Lower housing section: AISi 12.

Diaphragm: IIR for DG..S, DG..ST.

Weight:

270 to 320 g (9.5 to 11.3 oz) depending on equipment.

7.2.1 Recommended tightening torque

Component	Tightening torque [Ncm]
Cover screws	65
M16 x 1.5 cable gland	50
½" NPT conduit	170 (15 lb")
Rp 1/8 pipe connection on aluminium lower section	250
Rp 1/4 connection (1/4" NPT) on aluminium lower section	1300
Rp 1/8 connection on upper housing section	250
Clamping terminal screws	80
T15 test point screw	150

7.3 Electrical data

Switching capacity:

	U	I (cos φ = 1)	I (cos φ = 0.6)
DG	24–250 V AC	0.05–5 A	0.05–1 A
DG..G	5–250 V AC	0.01–5 A	0.01–1 A
DG..G	5–48 V DC	0.01–1 A	0.01–1 A
DG..T	max. 240 V AC	max. 5 A	max. 0.5 A
DG..TG	< 30 V AC/DC	max. 0.1 A	max. 0.05 A

If the pressure switch has switched a voltage > 24 V (> 30 V) and a current > 0.1 A at $\cos \varphi = 1$ or > 0.05 A at $\cos \varphi = 0.6$ once, the gold plating on the contacts will have been burnt through. It can then only be operated at this power rating or higher power rating.

Conductor diameter:

AWG 24 to AWG 13,

0.5 to 1.8 mm (0.02 to 0.07").

DG..T, DG..FT, DG..HT, DG..NT, DG..ST:

½" NPT conduit cable gland.

Electrical connection type: screw terminals.

7.4 DG adjusting range and switching hysteresis

Switching properties, see "Selection", page 7 (DG).

Type	Adjusting range*	Mean switching differential at min. and max. setting	Max. inlet pressure $p_{\max.}$ = withstand pressure	Difference between switching pressure and possible reset	Deviation from the switching point during testing pursuant to EN 1854	
	mbar	mbar	mbar	mbar	Gas pressure switches	Air pressure switches
DG 6U, DG 6B, DG 6S	0.5–6	0.2–0.3	100	–	± 15%	± 15% or 0.1 mbar
DG 10U, DG 10B, DG 10S	1–10	0.25–0.4	500	–	± 15%	± 15%
DG 30U, DG 30B, DG 30S	2.5–30	0.35–0.9	500	–	± 15%	± 15%
DG 50U, DG 50B, DG 50S	2.5–50	0.8–1.5	500	–	± 15%	± 15%
DG 150U, DG 150B, DG 150S	30–150	3–5	600	–	± 15%	± 15%
DG 400U, DG 400B, DG 400S	50–400	5–15	600	–	± 15%	± 15%
DG 500U, DG 500B, DG 500S	100–500	8–17	600	–	± 15%	± 15%
DG 10H, DG 10N	1–10	–	600	0.4–1	± 15%	± 15%
DG 50H, DG 50N	2.5–50	–	600	1–2	± 15%	± 15%
DG 150H, DG 150N	30–150	–	600	2–12	± 15%	± 15%
DG 500H, DG 500N	100–500	–	600	5–18	± 15%	± 15%

* Adjusting tolerance = ± 15% of the scale value.

Technical data

Type	Adjusting range*	Mean switching differential at min. and max. setting	Max. inlet pressure $p_{max.}$ = withstand pressure	Deviation from the switching point during testing pursuant to EN 1854	
				Gas pressure switches	Air pressure switches
DG 1,5I	-1.5 to -0.5 and +0.5 to +3	0.2–0.5	± 100	± 15%	± 15% or 0.4 mbar
DG 12I	-12 to -1 and +1 to +7	0.5–1	± 100	± 15%	± 15% or 0.5 mbar
DG 18I	-2 to -18	0.5–1.5	± 100	± 15%	± 15% or 0.5 mbar
DG 120I	-10 to -120	4–11	± 600	± 15%	± 15%
DG 450I	-80 to -450	10–30	± 600	± 15%	± 15%

* Adjusting tolerance = ± 15% of the scale value.

7.5 DG..T adjusting range and switching hysteresis

Switching properties, see "Selection", page 7 (DG..T).

Type	Adjusting range ¹⁾	Mean switching differential at min. and max. setting	Max. inlet pressure		Difference between switching pressure and possible reset	Deviation from the switching point during testing pursuant to EN 1854	
			with venting line ²⁾ psi (mbar)	without venting line ²⁾ psi (mbar)		"WC (mbar)	Gas pressure switches
DG 6T, DG 6FT, DG 6ST	0.2–2.4 (0.5–6)	0.08–0.12 (0.2–0.3)	8.5 (600)	2.4 (165)	–	± 15%	± 15% or 0.04 "WC
DG 10T, DG 10FT, DG 10ST	0.4–4 (1–10)	0.1–0.16 (0.25–0.4)	8.5 (600)	7 (480)	–	± 15%	± 15% or 0.04 "WC
DG 50T, DG 50FT, DG 50ST	1–20 (2.5–50)	0.3–0.6 (0.8–1.5)	8.5 (600)	7 (480)	–	± 15%	± 15%
DG 150T, DG 150FT, DG 150ST	12–60 (30–150)	1.2–2 (3–5)	8.5 (600)	7 (480)	–	± 15%	± 15%
DG 500T, DG 500FT, DG 500ST	40–200 (100–500)	3.2–6.8 (8–17)	8.5 (600)	7 (480)	–	± 15%	± 15%
DG 10HT, DG 10NT	0.4–4 (1–10)	–	8.5 (600)	7 (480)	0.16–0.4 (0.4–1)	± 15%	± 15%
DG 50HT, DG 50NT	1–20 (2.5–50)	–	8.5 (600)	7 (480)	0.4–0.8 (1–2)	± 15%	± 15%
DG 150HT, DG 150NT	12–60 (30–150)	–	8.5 (600)	7 (480)	0.8–4.8 (2–12)	± 15%	± 15%
DG 500HT, DG 500NT	40–200 (100–500)	–	8.5 (600)	7 (480)	2–7.2 (5–18)	± 15%	± 15%

1) Adjusting tolerance = ± 15% of the scale value.

2) Venting line connected to port 4, see "Project planning information", "Mechanical connection", page 25 (DG..T).

8 Dimensions

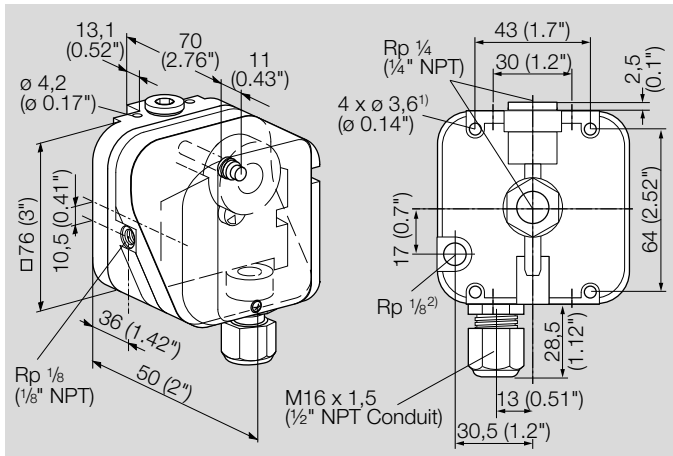

1) Holes 10 mm (0.4") deep, for self-tapping screws.

2) For DG..U, DG..H, DG..N, DG..I.

9 Converting units

See www.adlatus.org

10 Safety-specific characteristic values for SIL and PL

Certificates – see www.docuthek.com.

For a glossary of terms, see page 51 (Glossary).

For SIL	
Suitable for Safety Integrity Level	SIL 1, 2, 3
Diagnostic coverage DC	0
Type of subsystem	Type A to EN 61508-2, 7.4.3.1.2
Mode of operation	High demand mode pursuant to EN 61508-4, 3.5.12
For PL	
Suitable for Performance Level	PL a, b, c, d, e
Category	B, 1, 2, 3, 4
Common cause failure CCF	> 65
Application of essential safety requirements	Satisfied
Application of tried-and-tested safety requirements	Satisfied
For SIL and PL	
B _{10d} value of VAS 1	15,845,898 operating cycles
B _{10d} value U = 24 V DC, I = 10 mA; U = 230 V AC, I = 4 mA	6,689,477 operating cycles
B _{10d} value U = 24 V DC, I = 70 mA; U = 230 V AC, I = 20 mA	4,414,062 operating cycles
B _{10d} value U = 230 V AC, I = 2 A	974,800 operating cycles
Hardware fault tolerance (1 component/switch) HFT	0
Hardware fault tolerance (2 components/switches, redundant operation) HFT	1
Safe failure fraction SFF	> 90%
Fraction of undetected common cause failures β	≥ 2%

Relationship between the Performance Level (PL) and the Safety Integrity Level (SIL)

PL	SIL
a	–
b	1
c	1
d	2
e	3

10.1 Determining the PFH_D value, λ_D value and MTTF_d value

$$PFH_D = \lambda_D = \frac{1}{MTTF_d} = \frac{0,1}{B_{10d}} \times n_{op}$$

PFH_D = Probability of dangerous failure (HDM = high demand mode) [1/hour]

PFD_{avg} = Average probability of a dangerous failure of the safety function on demand (LDM = low demand mode)

λ_D = Mean dangerous failure rate [1/hour]

MTTF_d = Mean time to dangerous failure [hours]

n_{op} = Demand rate (mean number of annual operations) [1/hour]

10.2 Designed lifetime

Max. service life under operating conditions in accordance with EN 13611, EN 1854 for DG..U, DG..H, DG..N, DG..I: designed lifetime after date of production, plus max. ½ year in storage prior to first use, or once the given number of operating cycles has been reached, depending on which is achieved first:

Medium	Designed lifetime	
	Switching cycles	Time (years)
Gas	50,000	10
Air	250,000	10

10.3 Use in safety-related systems

For systems up to SIL 3 pursuant to EN 61508 and PL e pursuant to ISO 13849.

The devices are suitable for single-channel systems (HFT = 0) up to SIL 2/PL d, and up to SIL 3/PL e when two redundant devices are installed in a double-channel architecture (HFT = 1), provided that the complete system complies with the requirements of EN 61508/ISO 13849.

11 Safety information in accordance with EN 61508-2

11.1 Scope of application

The gas pressure switch triggers switch-on, switch-off or switch-over operations if a set switching point is reached.

11.2 Product description

See page 12 (Function) and page 5 (Application). for information about the product description and the device functions.

11.3 Reference documents

Operating instructions, see www.docuthek.com.

Certificate, see www.docuthek.com.

A web app for spare parts is available at www.adlatus.org.

A web app selecting the correct product is available at www.adlatus.org.

11.4 Applicable standards

Standards used for certification, see www.docuthek.com.

11.5 Safety function

The safety function involves the safe closing and opening of the circuits COM-NO and COM-NC, depending on the available pressure, and ensuring external tightness.

11.6 Safety instructions concerning operating limits

The function is only guaranteed when used within the specified limits – see page 30 (Technical data) or operating instructions at www.docuthek.com.

11.7 Installation and commissioning

Installation and commissioning procedures are described in the operating instructions.

11.8 Operation and maintenance

Operation and maintenance, see page 41 (Operation and maintenance).

Maintenance cycles, see page 50 (Maintenance cycles).

11.9 Troubleshooting

In the event of faults after maintenance work or function checks: remove the unit and return it to the manufacturer for inspection.

11.9.1 Repairs

If the test reveals that the pressure switch does not switch properly or is leaking, the device must be replaced. Repairs are not permitted.

11.10 Safety instructions concerning design verification

A Failure Mode and Effects Analysis has been carried out to assess possible design-related failures and to classify these into safe and dangerous failures.

11.11 Characteristic safety data/SIL capability

See page 37 (Safety-specific characteristic values for SIL and PL) and page 30 (Technical data).

11.12 Mode of operation

The pressure switches are suitable for a 100% duty cycle.

12 Operation and maintenance

12.1 Tightness test

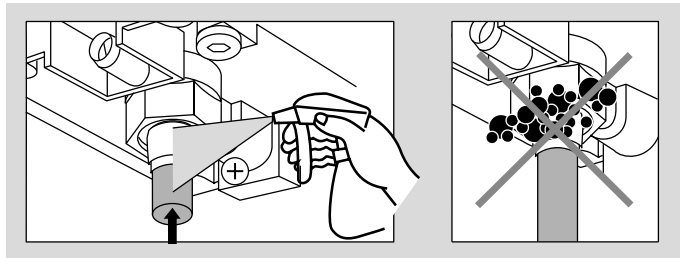

Apply pressure to device and test the joints using leak detection spray. No bubbles should form.

12.2 Function test on installed pressure switches

There are three ways of testing installed pressure switches for correct functioning. Ensure that the measuring instruments used comply with the accuracy defined for the process variable which is critical for safety.

12.2.1 Checking the switching point by measuring the process variable which is critical for safety

Examples:

Gas min. pressure switch

Safety-relevant function: should prevent the gas pressure from dropping so low that an unwanted air excess is generated during combustion.

Device used: DG 30B-3, hand wheel setting: 15 mbar.

System parameters: operating pressure is not measured (not important for this method), signal between COM and NO.

Test: measure the O_2 content in the flue gas, then slowly reduce the gas flow (manual valve). If there is too much O_2 (air excess), the DG should have switched off the system beforehand.

Flue gas differential pressure switch on the chimney

Safety-relevant function: the DG should prevent it being impossible to discharge the flue gases into the open air and should avoid incomplete combustion.

Device used: DG 6U-3, hand wheel setting: 5 mbar, was determined during commissioning of the system.

System parameters: operating pressure is not measured (not important for this method), signal between COM and NO.

Test: measure the CO content in the flue gas, then slowly close off the chimney. The DG should have switched off before incomplete combustion occurs.

12.2.2 Checking the switching point by measuring when installed

Gas max. pressure switch

Safety-relevant function: should prevent gas pressure from increasing and exceeding $p_{\max.}$ of the other components used and thus impairing/preventing correct functioning.

Device used: DG 150B-3, hand wheel setting: 100 mbar.

System parameters: operating pressure is not measured (not important for this method), signal between COM and NC.

Test: connect the pressure gauge to the DG pressure test point, slowly adjust the regulator upstream of the DG so that the gas pressure increases. The DG switch-on point (COM-NO) should be reached before attaining $p_{\max.}$ of the downstream components.

Gas min. pressure switch

Safety-relevant function: should prevent the gas pressure from dropping so low that incomplete combustion (formation of CO) occurs. A minimum of 40 bar is required to ensure proper functioning of the burners according to the information provided by the manufacturer.

Device used: DG 150U-3, hand wheel setting: 41.4 mbar.
 Hand wheel setting for the switch-off point is calculated as follows: $SPHE = SPA + (S_{min.} + (S_{max.} - S_{min.}) / (E_{max.} - E_{min.})) \times (SPA - E_{min.}) = 41.35 \text{ mbar}$

Type	Hand wheel adjusting range				Switch-off point	Example	
	Switch-on point		Switching differential			HS switching differential for hand wheel setting	SPHE hand wheel switch-on point
	$E_{min.}$	$E_{max.}$	$S_{min.}$	$S_{max.}$	STP		
DG 50	2.5	50	0.8	1.5	40	1.35	41.35

All specifications in mbar

System parameters: the operating pressure is 55 mbar.

Test:

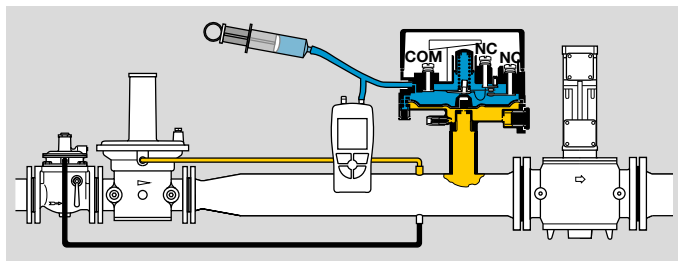

The pressure is measured at the test point. In this example, it is 55 mbar. Then the open 1/8" port, which is usually used to measure atmospheric pressure, is attached to a syringe and connected measuring instrument. The plunger is then pushed in slowly and the reaction of the system is

observed. If the pressure is around 15 mbar ($p_s = 55 - 15 = 40 \text{ mbar}$), the DG should switch off (COM-NC) and the system should shut down.

Flue gas differential pressure switch on the chimney

Safety-relevant function: the DG should stop it being impossible to discharge the flue gases into the open air (bird's nest on chimney) and prevent incomplete combustion (formation of CO). A minimum pressure differential of 5 mbar is required according to the information provided by the manufacturer.

Device used: DG 10U-3, hand wheel setting: 5.3 mbar for a switch-off point of 5 mbar.

System parameters: in normal operation, the pressure drops by 22 mbar due to the orifice, signal between COM and NO.

Test: a pressure of 22 mbar is measured at the test point. In this case, the line which leads to one of the 1/8" ports must be dismantled. The syringe and measuring instrument are connected to this port. The plunger is pushed in slowly and the DG should switch off at around 17.3 mbar. Signal between COM and NC.

Pressure switch for monitoring the fan pressure

Safety-relevant function: pre-purge to remove any air/gas mixture from the combustion chamber before ignition, then safeguarding of the combustion air. For this, the manufacturer specifies a switch-on point of 18 mbar.

Device used: DG 30B-3, hand wheel setting: 18 mbar.

System parameters: in normal operation, the fan generates a pressure of 28 mbar. In this case, the burner is not operating. It should only be checked whether the actual switching pressure is 18 mbar.

Test: connect pressure gauge to open 1/8" port. Then slowly pull out the plunger of the syringe (a vacuum is created in the blue area). The device should switch at around 18 mbar.

12.2.3 Checking the switching point or function check by rotating the hand wheel

This is the least precise method, see example at the end of the chapter. It only works if the operating pressure and switching point are within the setting range of the hand wheel.

Gas min. pressure switch

Safety-relevant function: should prevent the gas pressure from dropping so low that incomplete combustion (formation of CO) occurs. A minimum of 25 bar is required to ensure proper functioning of the burners according to the information provided by the manufacturer.

Device used: DG 50U-3, hand wheel setting: 26 mbar, switch-off point: 25 mbar.

Type	Hand wheel adjusting range				Switch-off point	Example	
	Switch-on point		Switching differential			HS switching differential for hand wheel setting	SPHE hand wheel switch-on point
	$E_{min.}$	$E_{max.}$	$S_{min.}$	$S_{max.}$			
DG 50	2.5	50	0.8	1.5	25	1.13	26.13

All specifications in mbar

System parameters: a pressure gauge installed in the system indicates a pressure of 40 mbar. Signal at COM-NC.

Test: the hand wheel is set to 50 mbar. The pressure switch should switch off (COM-NC). The hand wheel is then turned slowly in the “min.” direction. The DG should switch on at around 40 mbar.

Gas vacuum sensor DG..I

Safety-relevant function: should prevent the biogas pressure in the digester from dropping below -0.8 mbar, otherwise the hood will be damaged and air can enter the system.

Device used: DG 1,5I-3, hand wheel setting: -0.8 mbar.
Contact assignment, see template.

System parameters: a pressure gauge installed in the system indicates a pressure of 1.1 mbar. Signal at COM-NC.

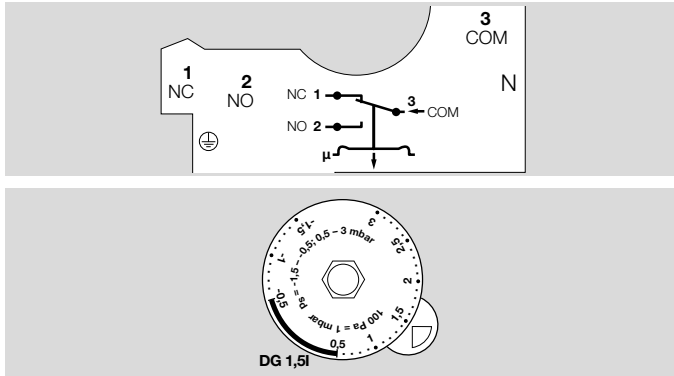

Test: turn hand wheel in the “plus” direction as far as it will go (signal at COM-NO), then turn the hand wheel in the “minus” direction until the signal changes to COM-NC (according to details on template). When simulated in a laboratory, this test produces the following results: signal at COM-NC (switch-off point) = 1.2 mbar, turn hand wheel back, switch-on point = 1.5 mbar.

Note: the contact assignment changes from the negative to the positive range, thus the switch-off point corresponds to the operating pressure in this test.

The switching point accuracy required can only be determined by the operator/project developer taking into ac-

count the entire system. The measuring method must also be based on this. The measuring accuracy that can be achieved will be shown in the following examples.

12.3 Accuracy of the tests

Example:

Gas_{min.} pressure switch, 3 pressure ranges which illustrate the varying accuracy of the methods compared to measurement to EN 1854.

Gas_{min.} pressure switch, switch-off point should be 2 mbar, hand wheel setting = 2.2*, operating pressure = 5 mbar

DG 6U-3	Hand wheel in mbar	Testing using test rig pursuant to EN 1854		Measurement using syringe method, operating pressure: 5 mbar		Estimation with hand wheel method, value read off on hand wheel	
		On	Off (actual)	Off ¹⁾	Off (actual)	On ²⁾	Off ²⁾
1st measurement	2.2	2.25	2.04	2.9	2.1	4.8	5.6
2nd measurement	2.2	2.24	2.04	3.2	1.8	4.8	5.6
3rd measurement	2.2	2.24	2.03	3.1	1.9	4.8	5.5

Gas_{min.} pressure switch, switch-off point should be 30 mbar, hand wheel setting = 31.2*, operating pressure = 40 mbar

DG 50U-3	Hand wheel in mbar	Testing using test rig pursuant to EN 1854		Measurement using syringe method, operating pressure: 40 mbar		Estimation with hand wheel method, value read off on hand wheel	
		On	Off (actual)	Off ¹⁾	Off (actual)	On ²⁾	Off ²⁾
1st measurement	31	33.0	32	8.9	31.1	39.0	40
2nd measurement	31	32.8	32	8.8	31.2	38.8	40
3rd measurement	31	32.9	32	8.9	31.1	39.0	40.5

* Hand wheel setting = 2.2 or hand wheel setting = 31.2, see page 49 (Examples for calculating the switch-on point when a switch-off point of x mbar is required)

Gas_{min.} pressure switch, switch-off point should be 100 mbar, hand wheel setting = 104, operating pressure = 130 mbar

DG 150U-3	Hand wheel in mbar	Testing using test rig pursuant to EN 1854		Measurement using syringe method, operating pressure: 130 mbar		Estimation with hand wheel method, value read off on hand wheel	
		On	Off (actual)	Off ¹⁾	Off (actual)	On ²⁾	Off ²⁾
1st measurement	104	108.5	103.1	34	96	135	142
2nd measurement	104	108.5	103.1	34	96	136	143
3rd measurement	104	108.5	103.2	35	95	135	142

Operation and maintenance

Gas_{min.} pressure switch, switch-off point should be 300 mbar, hand wheel setting = 310, operating pressure = 400 mbar

DG 500U-3	Hand wheel in mbar	Testing using test rig pursuant to EN 1854		Measurement using syringe method, operating pressure: 400 mbar		Estimation with hand wheel method, value read off on hand wheel	
		On	Off (actual)	Off ¹⁾	Off (actual)	On ²⁾	Off ²⁾
1st measurement	313	320.0	309.0	98	302	395	410
2nd measurement	313	320.4	308.9	98	302	395	410
3rd measurement	313	320.0	309.0	99	301	393	408

Gas_{max.} pressure switch, switch-on point should be 25 mbar, hand wheel setting = 25 mbar, operating pressure = 15 mbar

DG 50U-3	Hand wheel in mbar	Testing using test rig pursuant to EN 1854		Measurement using syringe method, operating pressure: 15 mbar		Estimation with hand wheel method, value read off on hand wheel	
		On	Off (actual)	On ³⁾	On (actual)	On ⁴⁾	Off ⁴⁾
1st measurement	25	25.98	24.97	10.9	25.9	15	16.5
2nd measurement	25	25.96	24.99	11	26	15	16.5
3rd measurement	25	26.05	24.98	10.9	25.9	15	16.5

- 1) *Min. pressure switch: connect syringe with pressure gauge to the upper chamber, push plunger in slowly, read off pressure at switching instant. The pressure read off must now be deducted from the operating pressure (previously measured at the pressure test point) in order to determine the actual switch-off point.*
- 2) *Min. pressure switch: only the switching point in the operating pressure range can be tested using this method. In this case, the DG 6U is switched on. Turn the hand wheel to the min. position (as far as it will go), then slowly turn it in the direction of the max. position until the switch-off point is reached. Then turn the hand wheel in the direction of the min. position and make a note of the switch-on point. The switch-on point corresponds to the operating pressure.*
- 3) *Max. pressure switch: connect syringe with pressure gauge to the upper chamber, pull plunger out slowly, read off negative pressure at switching instant. The pressure read off must be added to the operating pressure measured at the test point without a sign in order to determine the switching point.*
- 4) *Max. pressure switch: only the switching point in the operating pressure range can be tested using this method. In this case, the DG 50U is switched off (signal at COM-NC). Turn the hand wheel slowly to the min. position until the pressure switch switches on (COM-NO). The switch-on point corresponds to the operating pressure.*

12.3.1 Examples for calculating the switch-on point when a switch-off point of x mbar is required

Type	Hand wheel adjusting range		Switching differential		Switch-off point	Examples	
	Switch-on point					HS switching differential for hand wheel setting	SPHE hand wheel switch-on point
	$E_{min.}$	$E_{max.}$	$S_{min.}$	$S_{max.}$	STP		
DG 6	0.4	6	0.2	0.3	3	0.25	3.25
DG 10	1	10	0.25	0.4	5	0.32	5.32
DG 30	2.5	30	0.35	0.9	15	0.60	15.60
DG 50	2.5	50	0.8	1.5	40	1.35	41.35
DG 150	30	150	3	5	100	4.17	104.17
DG 400	50	400	5	15	200	9.29	209.29
DG 500	100	500	8	17	300	12.50	312.50

All specifications in mbar

$$SPHE = SPA + (S_{min.} + (S_{max.} \times x - S_{min.}) / (E_{max.} - E_{min.}) \times (SPA - E_{min.}))$$

13 Maintenance cycles

At least once a year, at least twice a year in the case of biologically produced methane.

14 Glossary

14.1 Diagnostic coverage DC

Measure of the effectiveness of diagnostics, which may be determined as the ratio between the failure rate of detected dangerous failures and the failure rate of total dangerous failures

NOTE: Diagnostic coverage can exist for the whole or parts of a safety-related system. For example, diagnostic coverage could exist for sensors and/or logic system and/or final elements. Unit: %

see EN ISO 13849-1

14.2 Mode of operation

High demand mode or continuous mode

Operating mode, where the frequency of demands for operation made on a safety-related system is greater than one per year or greater than twice the proof-test frequency

see EN 61508-4

14.3 Category

Classification of the safety-related parts of a control system in respect of their resistance to faults and their subsequent behaviour in the fault condition, and which is achieved by the structural arrangement of the parts, fault detection and/or by their reliability

see EN ISO 13849-1

14.4 Common cause failure CCF

Failures of different items, resulting from a single event, where these failures are not consequences of each other
see EN ISO 13849-1

14.5 Fraction of undetected common cause failures β

Fraction of undetected failures of redundant components due to a single event, whereby these failures are not based on mutual causes

NOTE: β is expressed as a fraction in the equations and as a percentage elsewhere.

see EN 61508-6

14.6 B_{10d} value

Mean number of cycles until 10% of the components fail dangerously

see EN ISO 13849-1

14.7 T_{10d} value

Mean time until 10% of the components fail dangerously

see EN ISO 13849-1

14.8 Hardware fault tolerance HFT

A hardware fault tolerance of N means that N + 1 is the minimum number of faults that could cause a loss of the safety function

see IEC 61508-2

14.9 Mean dangerous failure rate λ_D

Mean rate of dangerous failures during operation time (T_{10d}).

Unit: 1/h

see EN ISO 13849-1

14.10 Safe failure fraction SFF

Fraction of safe failures related to all failures, which are assumed to appear

see EN 13611/A2

14.11 Probability of dangerous failure PFH_D

Value describing the likelihood of dangerous failure per hour of a component for high demand mode or continuous mode. Unit: 1/h

see EN 13611/A2

14.12 Mean time to dangerous failure $MTTF_d$

Expectation of the mean time to dangerous failure

see EN ISO 13849-1:2008

14.13 Demand rate n_{op}

Mean number of annual operations

see EN ISO 13849-1

14.14 Average probability of dangerous failure on demand PFD_{avg}

(LDM = 1 – 10 switching cycles/year)

Average probability of a dangerous failure of the safety function on demand (LDM = low demand mode)

see EN 61508-6

For more information

The Honeywell Thermal Solutions family of products includes Honeywell Combustion Safety, Eclipse, Exothermics, Hauck, Kromschroder and Maxon. To learn more about our products, visit ThermalSolutions.honeywell.com or contact your Honeywell Sales Engineer.

Elster GmbH
Strotheweg 1, D-49504 Lotte
T +49 541 1214-0
hts.lotte@honeywell.com
www.kromschroeder.com

© 2021 Elster GmbH

We reserve the right to make technical modifications in the interests of progress.

