

Specifications of "NP" & "RG" AIRFLO® burners

NP-I & NP-II AIRFLO® burners

Differential gas pressure at burner inlet

For burner capacity =150 kW/ft (HHV)

Fuel	NP-I	NP-II
natural gas (10,9 kWh/Nm ³ HHV, sg = 0,6)	14 mbar	7 mbar
propane (25,79 kWh/Nm ³ HHV, sg = 1,57)	5 mbar	3 mbar

Note :

- For other capacities per foot or gases with different heating values and/or specific weights as shown in the above table, values for differential gas pressure will behave according to the normal laws of physics.
- Listed values are approximate net pressures at burner inlet, NOT taking into account any losses in piping/gas manifolds etc.
- Stated pressures are indicative. Actual pressures are function of altitude, type of fuel, gas quality.

Optimum operation parameters

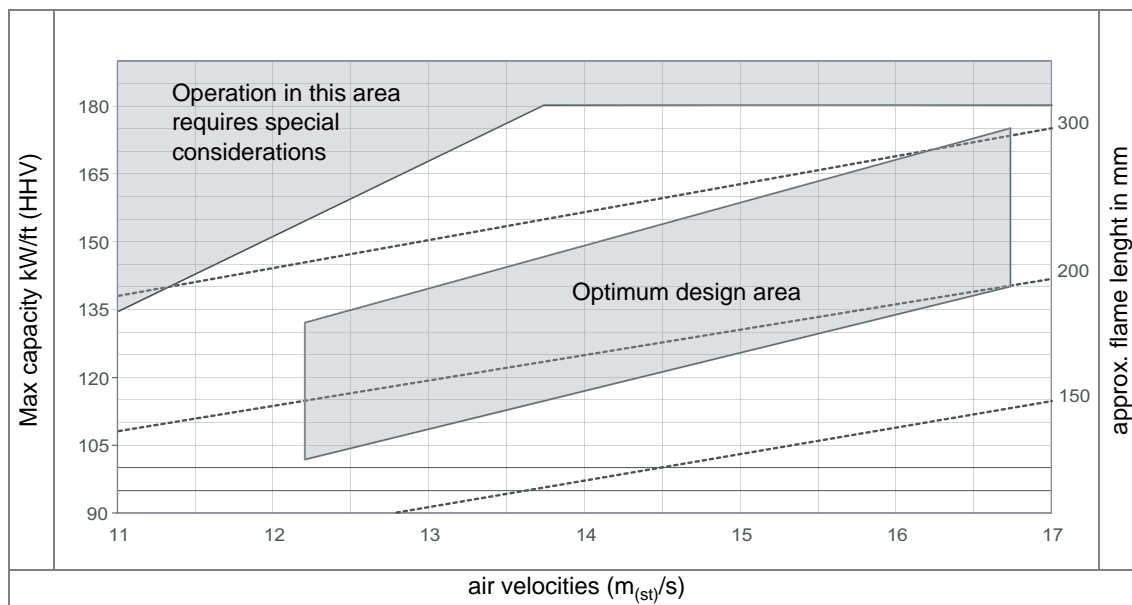

Note :

- Flame length is as measured from leading edge of mixing plates (see sketch on page 4-21.5-11).
EXAMPLE: Series NP-I AIRFLO® burner at 15 m_(st)/s and at 150 kW per foot would have an approximate flame length of 300 mm. Contact MAXON for operation outside the optimum operation area.
- **Airstream velocity** across and through the burner's mixing plates must be kept uniform and within desired limits by use of a silhouette profile plate through which the burner fires. Refer to page 4-21.5-11 for more details on sizing of this profile plate.
- **Pilot capacities** are nominally rated at 7,3 kW with natural gas differential pressure of 10 mbar to 15 mbar. Suitable for natural gas, propane and propane-air mixtures. Contact MAXON for applications on butane or other gases than specified here.

Minimum capacities

Minimum capacities are given as a guideline. They strongly depend on process conditions. .

Air velocities	m _(st) /s		11	12	13	14	15	16	17
Minimum capacity kW/ft (HHV)	NP-I	natural gas	4	5	5	6	6	7	8
		propane	not recommended		6	7	8	9	10
	NP-II	natural gas	5	6	6	7	8	8	9
		propane	not recommended		7	8	9	9	10

NP-III AIRFLO® burners

Differential gas pressure at burner inlet

For burner capacity =300 kW/ft (HHV)

Fuel	NP-III
natural gas (10,9 kWh/Nm ³ HHV, sg = 0,6)	14 mbar
propane (25,79 kWh/Nm ³ HHV, sg = 1,57)	5 mbar

Note :

- For other capacities per foot or gases with different heating values and/or specific weights as shown in the above table, values for differential gas pressure will behave according to the normal laws of physics.
- Listed values are approximate net pressures at burner inlet, NOT taking into account any losses in piping/gas manifolds etc.
- Stated pressures are indicative. Actual pressures are function of altitude, type of fuel, gas quality.

Optimum operation parameters

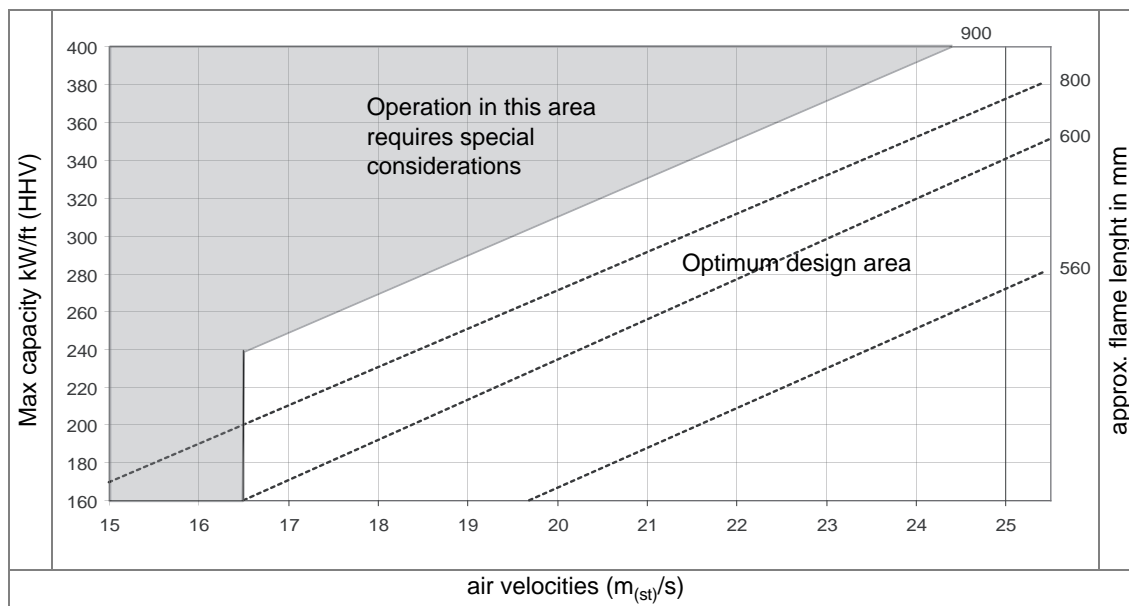

Note :

- Flame length is measured from leading edge of mixing plate (see sketch on page 4-21.5-11).
EXAMPLE: Series NP-III AIRFLO® burner at 20 m_(st)/s and 300 kW per foot would have an approximate flame length of 800 mm.
Contact MAXON for operation outside the optimum operation area (shaded area).
- **Airstream velocity** across and through the burner's mixing plates must be kept uniform and within desired limits by use of a silhouette profile plate through which the burner fires. Refer to page 4-21.5-11 for more details on sizing of this profile plate.
- **Pilot capacities** are nominally rated at 7,3 kW with natural gas differential pressure of 10 mbar to 15 mbar. Suitable for natural gas, propane and propane-air mixtures. Contact MAXON for applications on butane or other gases than specified here.

Minimum capacities

Minimum capacities are given as a guideline. They strongly depend on process conditions.

Air velocities m _(st) /s		15	17	18	19	20	22	23	24	25
Minimum capacity kW/ft (HHV)	NP-III natural gas	20	25	34	44	53	70	84	97	108
	NP-III propane	20	24	32	35	41	46	51	57	63

RG-IV AIRFLO® burners

Differential gas pressure at burner inlet

For burner capacity =150 kW/ft (HHV)

Fuel	RG-IV
natural gas (10,9 kWh/Nm³ HHV, sg = 0,6)	14 mbar

Note :

- For other capacities per foot or gases with different heating values and/or specific weights as shown in the above table, values for differential gas pressure will behave according to the normal laws of physics.
- Listed values are approximate net pressures at burner inlet, NOT taking into account any losses in piping/gas manifolds etc.
- Stated pressures are indicative. Actual pressures are function of altitude, type of fuel, gas quality.

Optimum operation parameters

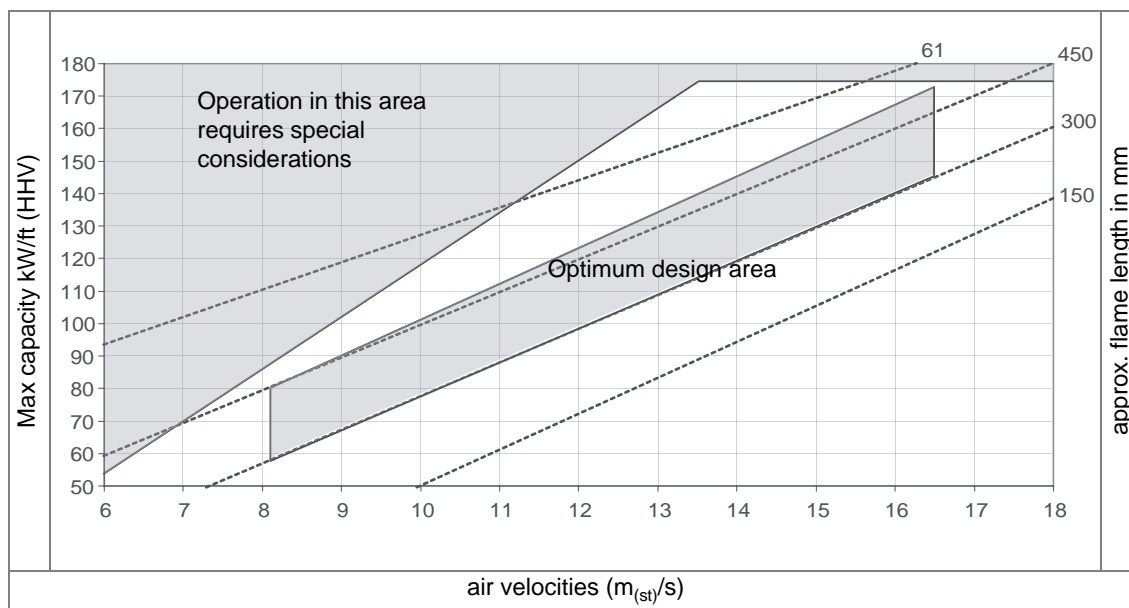

Note :

- Flame length is as measured from leading edge of mixing plates (see sketch page 4-21.5-11).
EXAMPLE: Series RG-IV AIRFLO® burner used with 2-speed blower at 15 m_(st)/s and 150 kW per foot or at 7,5 m_(st)/s and 75 kW per foot (flame length 350 mm– 150 kW / 300 mm – 75 kW).
Contact MAXON for operation outside the optimum operation area (light grey area).
- **Airstream velocity** across and through your burner's mixing plates must be kept uniform and within desired limits by use of a silhouette profile plate through which the burner fires. Refer to page 4-21.5-11 for more details on sizing of this profile plate.
- **Pilot capacities** are nominally rated at 7,3 kW with natural gas differential pressure of 10 mbar to 15 mbar. For natural gas only. Contact MAXON for applications on butane, propane, or other gases than natural gas.
- Capacity at half speed should be limited with fail-safe security.

Minimum capacities

Minimum capacities are given as a guideline. They strongly depend on process conditions.

Air velocities m _(st) /s	8	10	11	13	14	16	17
Minimum capacity kW/ft (HHV)	4	4	5	5	6	7	9

Materials of construction

	NP-I, NP-II, NP-III, RG-IV	NP-I-AL, RG-IV-AL
Burner body	gray iron ASTM A159-77 Grade G3000	Aluminum
Mixing plates	AISI 430 = W.S. 1.4016	AISI 430 = W.S. 1.4016
1 piece endplates [1]	gray iron ASTM A159-77 Grade G3000	steel plated
2 piece endplates flange	gray iron ASTM A159-77 Grade G3000	steel plated
plate	AISI 430 = W.S. 1.4016	AISI 430 = W.S. 1.4016
Fasteners	Aluminized and galvanized steel	Aluminized and galvanized steel

[1] NP only

Selection criteria

Air-stream velocity

Air-stream velocity across and through the burner's mixing plates must be kept uniform and within desired limits by use of a silhouette profile plate through which the burner fires. A 150 mm (minimum) profile plate should be installed surrounding the interior duct walls at the leading edge of the burner mixing plates.

- 1) Direction of process air movement
- 2) Adjustable profile plate
- 3) Fixed profile plate
- 4) Universal support bracket
- 5) Differential pressure switch

A : Minimum 150 mm

B : Minimum 150 mm

L : Flame length

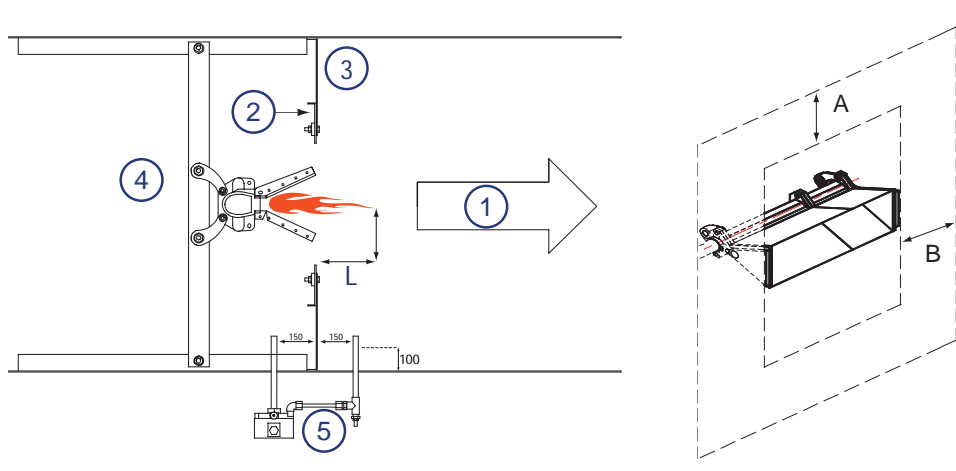

Optimum design ranges for Series "NP" and "RG" AIRFLO® burners are shown in the graphs on page 4-21.5-7, page 4-21.5-8 and page 4-21.5-9. Velocities in m³_(st)/h are measured with a velometer directly in the duct at the plane of the profile plate and leading edge of burner mixing plates (see above sketch).

To determine profile opening areas, add burner displacement areas (cm²/section) from table on page 4-21.5-12 for complete burner assembly to "Net Free Area" of duct :

$$\text{"Net free area" of duct (cm}^2\text{)} = \frac{\text{Fan volume m}^3\text{(st)h}}{\text{Velocity (m/s x 3600)}} \times 10\,000 = \dots\dots\dots\text{cm}^2$$

m³_(st)/h = fan volume at 288 Kelvin and 1 atmosphere

$$\text{Net free area (cm}^2\text{)} + \text{burner displacement (cm}^2\text{)} = \text{profile area (cm}^2\text{)}$$

The relation between velocity and pressure differential across the burner slightly differ with the ratio between net profile area and total duct section.

Velocities should always be confirmed and established by use of a velometer on actual field site installation.

Velocity factors (fresh air - 15° C - ρ = 1,293 kg/Nm³)

Velocity	m/s	8	9	10	11	12	13	14	15	16	17	18	19	20
Air pressure differential	mbar	0,39	0,50	0,61	0,74	0,88	1,04	1,20	1,38	1,57	1,77	1,99	2,21	2,45

Note:

- differential air pressures are measured via pressure test points located 150 mm upstream and 150 mm downstream of the profile plate, near the duct wall at 100 mm into the duct. (See sketch on page 4-21.5-11)
- typical data which may not represent precise pressure drops for all design cases.

Inlet feed limitations

The maximum number of units of burner per gas inlet connection should be limited in order to guarantee correct gas distribution inside the burner manifold. Insufficient or badly distributed gas inlet connections may affect flame length, pollutant emissions and temperature distribution downstream of the burner. Refer to the table below as a guideline for natural gas, based on a maximum capacity limitation of 150 kW/ft (NP-I & NP-II) and 300 kW/ft (NP-III). The number of gas inlets should be reconsidered for gases different from natural gas (for example gases with lower calorific value).

Contact MAXON for more details.

	NP-I	NP-II	NP-III	RG-IV
1 1/4" end inlet flange	≅ 4 ft	≅ 4 ft	≅ 2 ft	≅ 4 ft
1 1/2" back inlets	≅ 5 ft	≅ 5 ft	≅ 4 ft	≅ 5 ft

Burner sections

Burner type	Cast iron bodies with AISI 430 mixing plates and carbon steel fasteners				Alu bodies with AISI 321 mixing plates and carbon steel fasteners		Alu bodies with AISI 321 mixing plates and stainless steel fasteners		Sketch [1]
	NP-I	NP-II	NP-III	RG-IV	NP-I	RG-IV	NP-I	RG-IV	
Description	Designation								
150 mm straight section	NP-I-6	NP-II-6	NP-III-6	RG-IV-6	NP-I-6 (AL)	RG-IV-6 (AL)	NP-I-6 (ALSS)	RG-IV-6 (ALSS)	1
305 mm straight section	NP-I-12	NP-II-12	NP-III-12	RG-IV-12	NP-I-12 (AL)	RG-IV-12 (AL)	NP-I-12 (ALSS)	RG-IV-12 (ALSS)	2
455 mm straight section	NP-I-18	NP-II-18	NP-III-18	RG-IV-18	N/A [2]	N/A	N/A	N/A	3
610 mm straight section	NP-I-24	NP-II-24	NP-III-24	RG-IV-24	N/A	N/A	N/A	N/A	4
150 mm x 150 mm elbow section	NP-I-L	NP-II-L	NP-III-L	RG-IV-L	N/A	N/A	N/A	N/A	5
305 mm x 150 mm T-section	NP-I-T	NP-II-T	NP-III-T	RG-IV-T	NP-I-T (AL)	RG-IV-T (AL)	NP-I-T (ALSS)	RG-IV-T (ALSS)	6
305 mm back inlet section	NP-I-12B	NP-II-12B	NP-III-12B	RG-IV-12B	NP-I-12B (AL)	RG-IV-12B (AL)	NP-I-12B (ALSS)	RG-IV-12B (ALSS)	7
36 in. back inlet section	NP-I-36B	NP-II-36B	NP-III-36B	RG-IV-36B	N/A	N/A	N/A	N/A	8
150 mm pilot assembly section includes built-in pilot	NP-I-6P	NP-II-6P	NP-III-6P	RG-IV-6P	N/A	N/A	N/A	N/A	1

[1] Sketch see page 4-21.5-13

[2] N/A = not applicable

Burner displacement and weight [1]

Burner type	Cast iron bodies with AISI 430 mixing plates and carbon steel fasteners				Alu bodies with AISI 321 mixing plates and carbon steel fasteners				Alu bodies with AISI 321 mixing plates and stainless steel fasteners			
	Area cm ² /section	Weight kg	Area cm ² /section	Weight kg	Area cm ² /section	Weight kg	Area cm ² /section	Weight kg	Area cm ² /section	Weight kg	Area cm ² /section	Weight kg
150 mm straight section	232	2,3	307	2,4	232	1,5	307	1,7	232	1,5	307	1,7
305 mm straight section	465	4,1	613	4,4	465	2,9	613	3,4	465	2,9	613	3,4
455 mm straight section	697	7	920	7,5	N/A [2]	N/A	N/A	N/A	N/A	N/A	N/A	N/A
610 mm straight section	929	9	1226	9,7	N/A	N/A	N/A	N/A	N/A	N/A	N/A	N/A
150 mm x 150 mm elbow section	418	4,1	557	4,4	N/A	N/A	N/A	N/A	N/A	N/A	N/A	N/A
305 mm x 150 mm T-section	557	6	697	6,4	557	0,6	697	4,7	557	3,9	697	4,7
305 mm back inlet section	465	4,9	613	5,2	465	3,1	613	3,6	465	3,1	613	3,6
915 mm back inlet section	1115	12	1394	12,8	1115	7,8	1394	9,5	1115	7,8	1394	9,5
150 mm pilot assembly section includes built-in pilot	232	4,5	307	2,5	N/A	N/A	N/A	N/A	N/A	N/A	N/A	N/A

[1] Sketches see page 4-21.5-13. Refer to page 4-21.5-19 for dimensions.

[2] N/A = not applicable



1



2

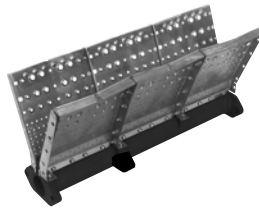

3

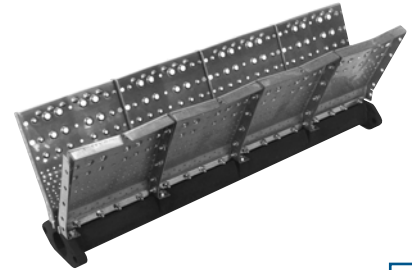

4



5

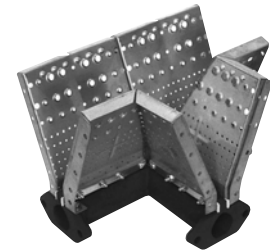

6



7











- 1) NP/RG-*-6
- 2) NP/RG-*-12
- 3) NP-*-18[1]
- 4) NP-*-24[1]
- 5) NP-*-L[1]
- 6) NP/RG-*-T
- 7) NP-12B

[1] not available in "RG" AIRFLO®

Note: mixing plates of Series "RG" AIRFLO® burners are slightly longer. See dimensions on page 4-21.5-19.

Pilots, end closures and end inlet flange sets for Series "NP" AIRFLO® burners







All open ends of burner assembly must be closed off with one of these end closures or pilots. One-piece cast end closures should not be used if temperature rise exceeds 150° C .

Series "NP" AIRFLO® burners			
Designation	Description	Model	Weight (kg)
NP-EC	One piece end closure set		2,0
NP-EP	Two piece end plate set		3,2
NP-EC-SI-3/4" UV [1]	One piece pilot set including SI with 3/4"-NPT UV-connection		2,1
NP-EC-SI-1/2" FR [1]	One piece pilot set including SI with 1/2"-NPT FR-connection		2,0
NPF-1-1/4"-FR-SI-1pc-ANSI [1]	One piece pilot set including SI with 1-1/4" NPT gas inlet connection and FR/UV-connection		2,9
NPF-1-1/4"-FR-SI-1pc-ISO [1]	One piece pilot set including SI with Rp 1-1/4 gas inlet connection and FR/UV-connection		
NPF-1-1/4"-FR-SI-2pc-ANSI [1]	Two piece pilot set including SI with 1-1/4" NPT gas inlet connection and FR/UV-connection		3,5
NPF-1-1/4"-FR-SI-2pc-ISO [1]	Two piece pilot set including SI with Rp 1-1/4 gas inlet connection and FR/UV-connection		
NPF-1-1/4"-EP-ANSI	Two piece End inlet flange set with 1-1/4" NPT gas inlet connection		3,2
NPF-1-1/4"-EP-ISO	Two piece End inlet flange set with Rp 1-1/4 gas inlet connection		
NP-PAK w/SI [1]	Two piece pilot set with SI and FR/UV-connection		3,6
NP-PAK w/AO-SI [1]	Two piece pilot set with SI, FR/UV-connection and adjustable orifice for pilot gas flow		3,8
NP-PAK w/AO-SI-cock-tube [1]	Two piece pilot set with SI, FR/UV-connection, adj.orifice, cock and tubing for pilot gas flow		4,4
NP-6P pilot section	Pilot section w/Built-in pilot includes two piece pilot set with SI and FR/UV-connection onto its own special 6" Series "NP" AIRFLO® burner assembly		5,0

[1] SI = spark ignitor - UV = connection for flame scanner
FR = connection for flame rod

Pilots, end closures, and end inlet flange sets for Series "RG" AIRFLO® burners

All open ends of burner assembly must be closed off with one of these end closures or pilots. One-piece cast end closures should not be used if temperature rise exceeds 150° C

Series "RG" AIRFLO® burners			
Designation	Description	Model	Weight (kg)
RG-EP-2pc	Two piece end plate set		1,1
RGF-1-1/4"-EP-2pc-ANSI	Two piece end plate set with 1-1/4" NPT gas connection		1,1
RGF-1-1/4"-EP-2pc-ISO	Two piece end plate set with Rp 1-1/4 gas connection		
RGF-1-1/4"-FR-SI-2pc-ANSI	^[1] Two piece pilot set with 14 mm SI, FR/UV-connection and 1-1/4" NPT gas connection		1,5
RGF-1-1/4"-FR-SI-2pc-ISO	^[1] Two piece pilot set with 14 mm SI, FR/UV-connection and Rp 1-1/4 gas connection		
RG-PAK pilot set w/SI-2pc	^[1] Two piece pilot set with SI and FR/UV-connection		1,6
RG-PAK pilot set w/AO-SI	^[1] Two piece pilot set with SI, FR/UV-connection and adjustable orifice for pilot gas flow		1,7
RG-PAK pilot set w/AO-SI-cock-tube	^[1] Two piece pilot set with 14 mm SI, FR/UV-connection, adjustable orifice, cock and tubing for pilot gas flow		2,3
RG-6P pilot section	Pilot section w/Built-in pilot includes two piece pilot set with SI and FR/UV-connection onto its own special 6" Series "RG" AIRFLO® burner assembly		4,7

[1] FR = connection for flame rod
SI = spark ignitor

Process flows and oxygen content

Series "NP" AIRFLO® and "RG" AIRFLO® burners are used only for the heating of fresh air in motion. Fresh air means air with 21 % oxygen, at ambient temperature, or indirectly preheated via a steam or water coil.

It is not recommended to use the burner in recirculating air systems.

NP-I , NP-II and RG-IV AIRFLO® burners may be used if temperature rise does not exceed 450° C

NP-III can be used to heat fresh air up to 650° C

Max. temperature of the fresh air entering the burner is 320° C

Velocity and air flow at operating temperature must be uniform and constant for Series "NP" AIRFLO® burners.

Series "RG" AIRFLO® burners can operate at 50 % and 100 % of the flow, typically applicable in two-speed air handling systems. Precautions should be taken to prevent overfiring of the burner in such conditions.

Piloting & ignition

Series "NP" and "RG" AIRFLO® burners are standard equipped with raw gas pilots to ignite the main flame. Pilot burner is incorporated in the burner end plate. Depending on the burner configuration, MAXON offers the choice between a complete range of pilot end plate sets. See tables on page 4-21.5-14 and page 4-21.5-15 for proper selection or contact MAXON for more detailed information.

Permanent pilot operation is not advised. Use main burner at minimum capacity for continuous operation.

Also direct ignition of the burner is possible, as far as acceptable by local regulations.

Use minimally 5000 V/200 VA ignition transformer for sparking of the spark ignitor. Contact MAXON for optional ignition equipment in hazardous location.

Locate one pilot valve close enough to the pilot burner gas inlet, to guarantee fast and reliable ignition of the pilot burner.

Typical ignition sequence

- Pre-purge of the combustion chamber and installation, according to the applicable codes and the installation requirements.
- Gas control valve in minimum position.
- Pre-ignition (typically 2 s sparking in air). Open pilot gas valves and continue to spark (typically 5 s to 10 s).
- Stop sparking, continue to power the pilot gas valves and start flame detection. Trip the burner in case no flame detected from this point on.
- Check pilot flame stability (typical 5 s to 10 s to prove stable flame).
- Open main gas valves and allow enough time for the fuel gas to reach the burner (typical 5 s or the time that gas needs to reach the burner).
- Close the pilot gas valves.
- Release to modulation (allow modulation of the gas control valve).
- Above sequence shall be completed to include all required safety checks during the start-up of the burner (process & burner safeties).
- Be advised that some regional codes require proving of cross-ignition by sensing flame at both ends of long burners.

Flame supervision

Standard connections for flame detection equipment are provided on the different end plates. Refer to selection tables on page 4-21.5-14 and page 4-21.5-15.

Only use these connections for correct flame-safeguarding. One-piece end plates have one connection for UV-scanner (scanning parallel to the burner-manifold) and flame rods (mounted parallel with burner body). Two piece end plates have 2 additional alternative connections for flame rod (45°-angle with burner-manifold).

Capacity control

Series "NP" and "RG" AIRFLO® burners are raw gas burners firing in a constant process air flow. Only gas flow to the burner is modulated by the use of a gas control valve. (MAXON Series "CV" valves, "A"-, "M"- or "P"-SYNCHRO® valves, SMARTLINK® CV).

Mechanically limit the minimum gas flow to the burner to guarantee stable flame at minimum fire.

Assure that the burner is not overfired by limitation of the max. position of the gas control valve.

Changes of process air temperature, system back pressure and other parameters could cause failures or unsafe conditions if the burner control system is not designed to compensate for these. Contact MAXON for assistance.

Manifolding

It is extremely important that the piping between the gas control valve (pipe-train) and the burner inlet is correctly designed to ensure equal distribution of the gas to the burner inlet(s). Particularly with burners with multiple gas inlets, special attention should be given to this. Wrong choice of pipe-diameters, incorrect construction of branch connections, wrong positions of elbow and insufficient straight pipe-length to the burner inlet are some of the factors that may influence burner performance dramatically.

Below are a few general guidelines to take into consideration when designing the gas manifold (contact MAXON for any questions or advice) :

In case there are 2 burners on each side of a process air heater, the length of pipe of each side should be the same, so that the pressure in the 2 lines can equalize (see Fig. 1)

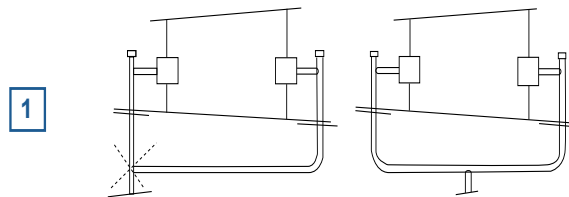

The pipe length A between any manifold offtake or elbow and burner inlet should be at least 4 pipe diameters (see Fig. 2) of the nipple used or 2 1/2 times the main manifold pipe diameter, whichever is larger. ($4 X < A > 2 \frac{1}{2} Y$).

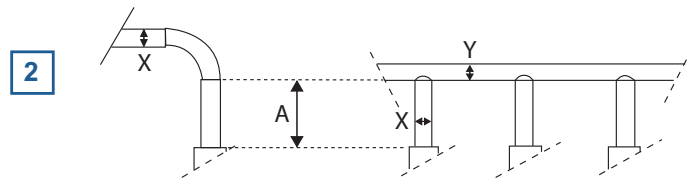

An offtake from a manifold should be straight and not in stream as shown in Fig. 3. Also the offtake should be welded on the manifold in such a way that the smaller pipe does not stick into the main manifold, (saddle weld) thus avoiding turbulence at the take-off point (see Fig. 4). The manifold should continue at least 2 pipe diameters beyond the last take-off (see Fig. 5).

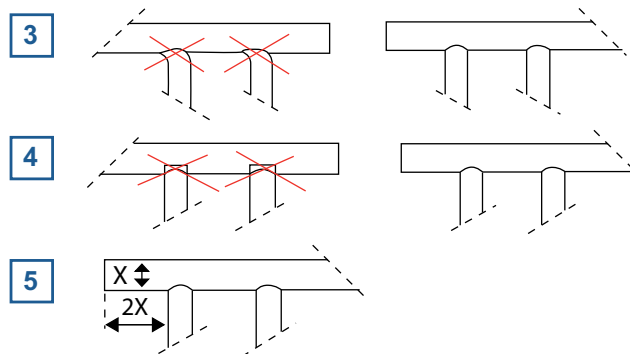

Staged combustion

Series "NP" and "RG" AIRFLO® burners combine extremely stable operation with high performance on temperature distribution and on turndown.

By the use of staged combustion, turndown may even be dramatically increased.

Contact MAXON for more information.

Fuels

Series "NP" AIRFLO® burners are suitable for natural gas, propane and propane-air mixtures. Series "RG" AIRFLO® burners are standard designed for natural gas only. Contact MAXON for other gases.

Expected Emissions

		NP-I , II [1] - natural gas [2] - fresh process air firing [3] [4]					
V_p	[5]	Capacity/ft	kW	100	150	200	250
10 m/s	CO	mg/MJ	40	50	50	50	
	NOx	mg/MJ	40	47	55	50	
15 m/s	CO	mg/MJ	160	50	50	50	
	NOx	mg/MJ	34	35 [6]	39	48	
20 m/s	CO	mg/MJ	380	200	100	90	
	NOx	mg/MJ	23	29	31	31	

[1] Typical emissions of NP-I and NP-II burners

[2] Natural gas with 10.9 kWh/Nm³ HHV, sg = 0,6

[3] Fresh process air 15° C – 21 % O₂

[4] Temperature increase $\Delta T < 250^\circ \text{C}$

[5] Air stream velocity (see page 4-21.5-11) across the burner with $A_p/A_d = 0,35$ for 20 m/s, $A_p/A_d = 0,42$ for 15 m/s, and $A_p/A_d = 0,62$ for 10 m/s

[6] Optimum operation area

Emissions are, however, highly influenced by different burner and process related factors such as type of gas, burner capacity, air stream velocity, process air humidity and temperature, relation duct/profile plate area etc. We strongly advise to contact MAXON for evaluation of expected emissions on your typical application.

No guarantee of emissions is intended or implied on the above. Contact MAXON for specific evaluation of your process and application for a written guarantee of emissions.

Dimensions

Burner sections

All "NP" AIRFLO® burners shown are available in NP-I, NP-II, and NP-III versions. Use (I, II, III) instead of asterisk (*) in burner designation when ordering.

NP-I and RG-IV AIRFLO® burners are also available with aluminum bodies. See burner sections on page 4-21.5-12 for burner displacement and weights. Dimensions are identical.

Series "NP" AIRFLO® burners differ from Series "RG" AIRFLO® burners only by length of mixing plate.

Dimensions in mm unless stated otherwise					
Burner type	A	B	C	D	E
NP-*	178	198	27	86	56
RG-IV	222	257	27	86	56

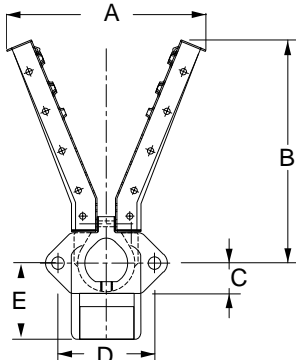

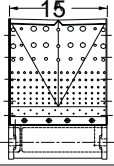
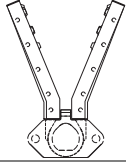
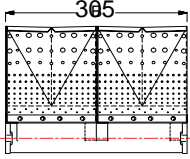
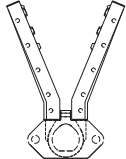
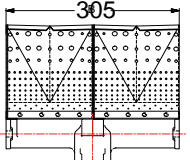
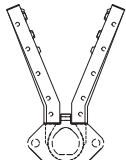
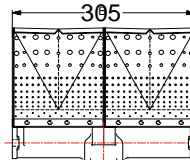
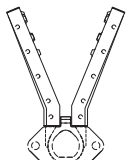
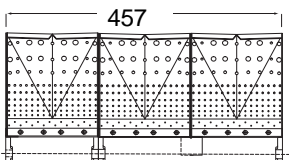
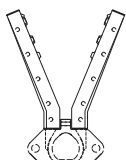
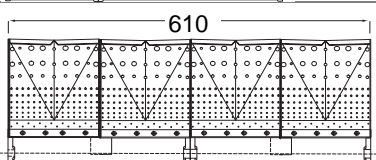
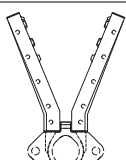
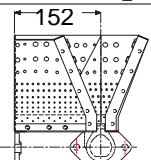
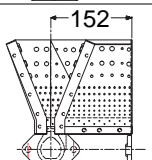
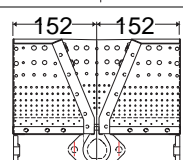
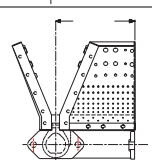
Dimensions in mm unless stated otherwise		
Designation	Dimensions	
NP-*-6 or NP-*-6P RG-IV-6 or RG-IV-6P		
NP-*-12 RG-IV-12		
NP-*-12B (ANSI) RG-IV-12B (ANSI)		
NP-*-12B (ISO) RG-IV-12B (ISO)		
NP-*-18 RG-IV-18		
NP-*-24 RG-IV-24		
NP-*-L RG-IV-L		
NP-*-T RG-IV-T		

Endplates Series "NP" AIRFLO® burners

All open ends of burner assembly must be closed off with one of these end closures or pilots.
One-piece cast end closures should not be used if temperature rise exceeds 150° C

Designation	Sketch	Test conn. [1]	Gas inlet [2]	UV conn. [3]	SI conn. [4]	FR conn. [5]	FR alt conn. [5*]	Pilot conn. [6]
NP-EC	1	-	-	-	-	-	-	-
NP-EP	7	Rp 1/8	-	-	-	-	-	-
NP-EC-SI-3/4" UV	2	-	-	Rp 3/4	14 mm	-	-	Rp 1/8
NP-EC-SI-1/2" FR	2	-	-	-	14 mm	Rp 1/2	-	Rp 1/8
NPF-1-1/4"-FR-SI-1pc-ANSI	3	-	1-1/4" NPT	3/4" NPT	14 mm	1/4" NPT bushed	-	1/8"
NPF-1-1/4"-FR-SI-1pc-ISO	3	-	Rp 1.1/4	Rp 3/4	14 mm	Rp 1/4 bushed	-	Rp 1/8
NPF-1-1/4"-FR-SI-2pc-ANSI	4	-	1-1/4" NPT	3/4" NPT	14 mm	1/4" bushed	1/4"	1/8" NPT
NPF-1-1/4"-FR-SI-2pc-ISO	4	-	Rp 1.1/4	Rp 3/4	14 mm	Rp 1/4 bushed	1/4"	Rp 1/8
NPF-1-1/4"-EP-ANSI	5	-	1-1/4" NPT	-	-	-	-	-
NPF-1-1/4"-EP-ISO	5	-	Rp 1.1/4	-	-	-	-	-
NP-PAK w/SI	6	Rp 1/8	-	Rp 3/4	14 mm	Rp 1/4 bushed	1/4"	Rp 1/4

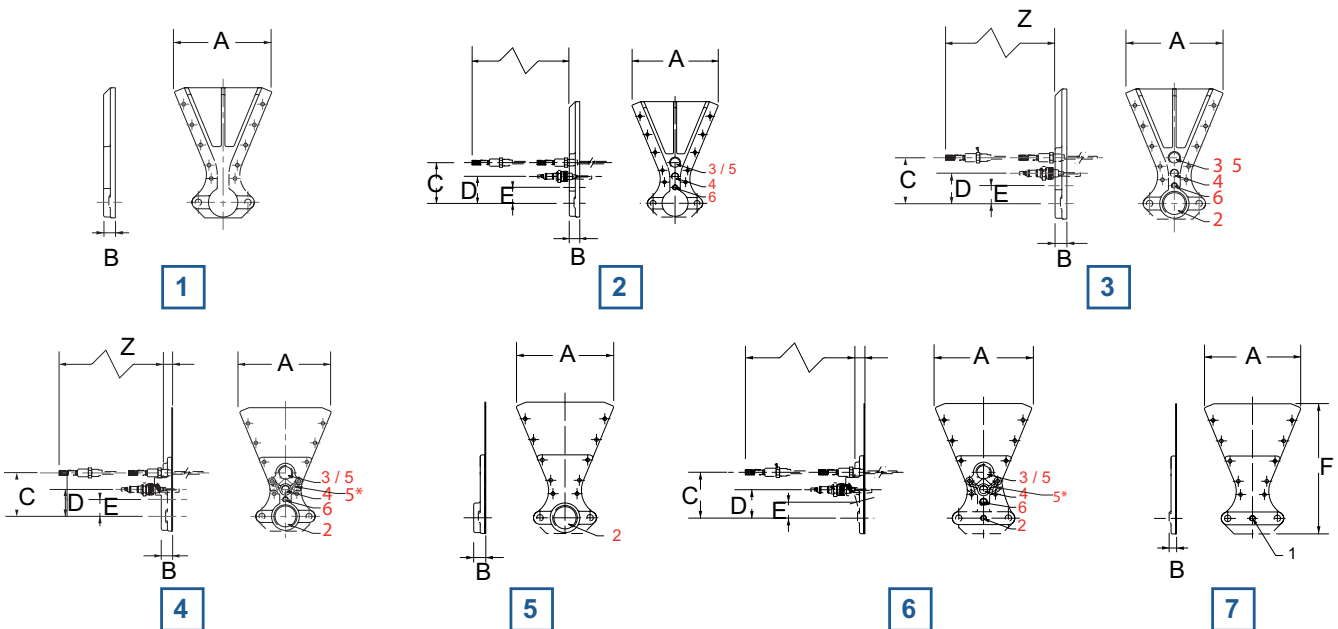

Dimensions in mm unless stated otherwise							
Sketch	A	B	C	D	E	F	Z [1]
1	168	21	-	-	-	-	-
2	168	21	79	52	32	-	242
3	168	21	79	52	32	-	242
4	168	21	79	49	31	-	242
5	168	-	79	49	28	-	242
6	168	21	79	49	31	-	242
7	168	11	-	-	-	226	-

[1] space for flame rod removal

Endplates Series "RG" AIRFLO® burners

Note : all open ends of burner assembly must be closed off with one of these end closures or pilots. One-piece cast end closures should not be used if temperature rise exceeds 150°C.

Designation	Sketch	Test conn. [1]	Gas inlet [2]	UV conn. [3]	SI conn. [4]	FR conn. [5]	FR alt conn [5*]	Pilot conn. [6]
RG-EP	1	Rp 1/8	-	-	-	-	-	-
RGF-1-1/4"-FR-SI-2pc-ANSI	2	-	1-1/4" NPT	1/2"	14 mm	1/4" bushed	1/4"	1/8"
RGF-1-1/4"-FR-SI-2pc-ISO	2	-	Rp 1.1/4	Rp 1/2	14 mm	Rp 1/4 bushed	1/4"	Rp 1/8
RGF-1-1/4"-EP-ANSI	3	-	1-1/4" NPT	-	-	-	-	-
RGF-1-1/4"-EP-ISO	3	-	Rp 1.1/4	-	-	-	-	-
RG-PAK pilot set w/SI	4	Rp 1/8	-	Rp 1/2	14 mm	Rp 1/4 bushed	1/4"	Rp 1/4

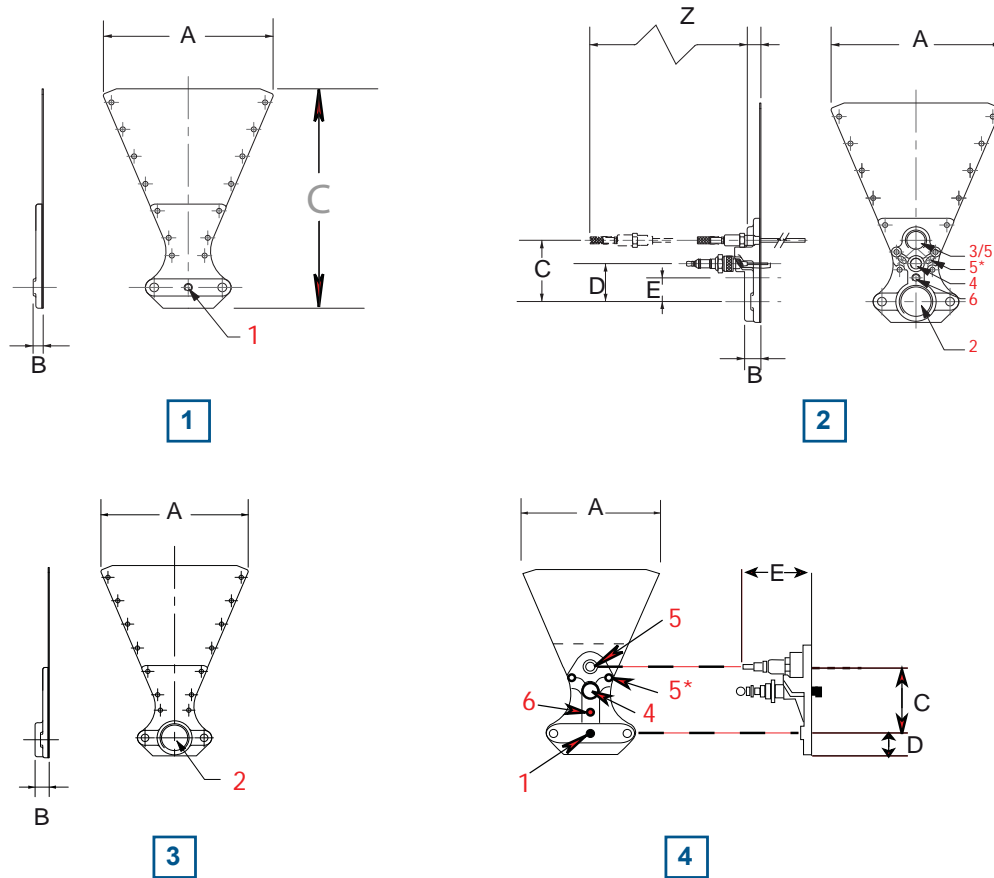

Dimensions in mm unless otherwise stated						
Sketch	A	B	C	D	E	Z [1]
1	216	13	-	-	-	-
2	216	11	79	49	32	242
3	216	19	79	52	31	-
4	216	21	-	-	-	-
5	216	11	79	49	32	242

[1] space for flame rod removal

Accessories / Replacement items

14 mm spark ignitor

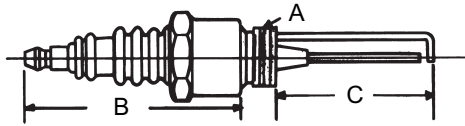

Dimensions in mm unless stated otherwise		
A	B	C
14 mm Thd.	52	38

Flame rod 1/4" NPT

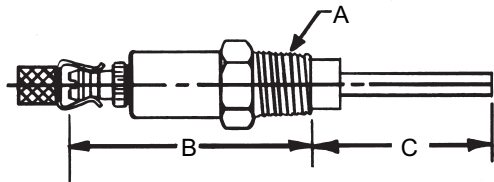

Dimensions in mm unless stated otherwise		
A	B	C
1/4" Thd.	51	191

Adjustable orifice

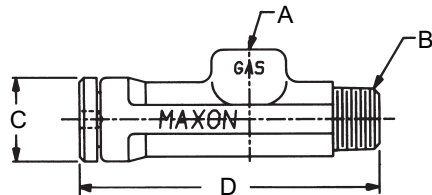

Dimensions in mm unless stated otherwise			
A	B	C	D
3/8" NPT	1/4" NPT	23	82

Division plate

Provides isolation of burner feed where desirable.

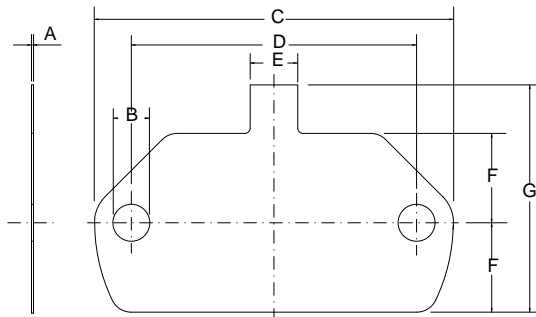

Dimensions in mm unless stated otherwise						
A	B	C	D	E	F	G
0,6	11	108	85,5	14,5	27	68,5

Profile plate mounting bracket

On certain high temperature rise applications of AIRFLO® line burners, it is advantageous to partially close off the square or rectangular openings within the burner assembly in addition to installing the profile plate around the outside of the burner in order to increase the velocity sufficiently.

The stainless steel profile mounting plate bracket, illustrated in the sketches below, is used to support plates for this purpose. The plate used to close off a portion of the openings will need to be sized for each individual application and therefore will be fabricated and installed by the customer.

- 1) Diam. = Rp 1/4
- 2) Profile plate mounting bracket
- 3) Profile plate

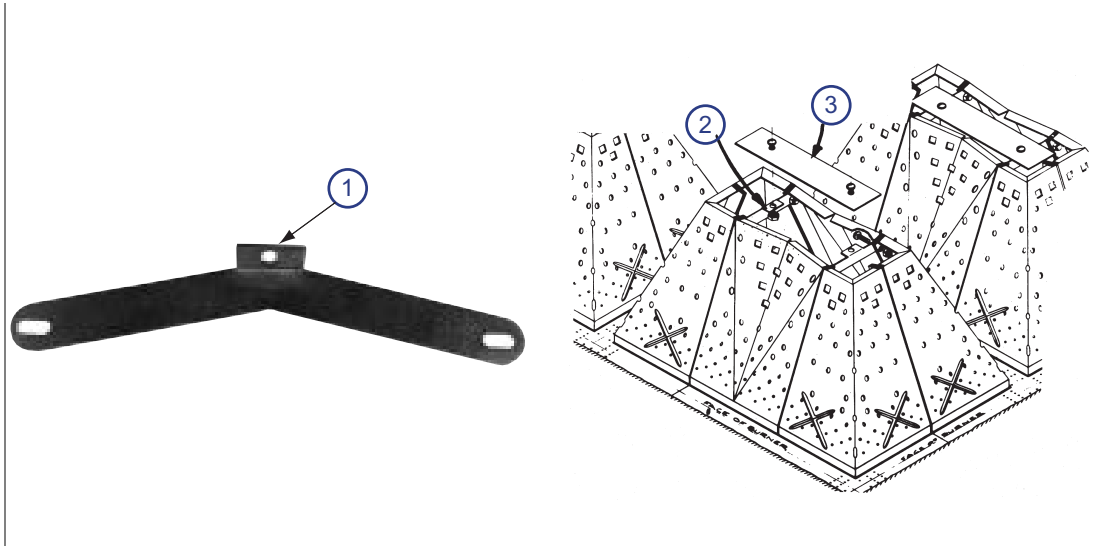

Dimensions in mm unless stated otherwise														
A	B	C	D	E	F	G	H	I	J	K	L	M	N	O
5,6	6,4	5,6	12,7	25,4	17,5	37,3	90°	83,3	5,6	9,5	9,5	19	27,8	167,5

Burner support brackets

- 1) 1-piece burner support bracket
- 2) 2-piece burner support bracket [1]

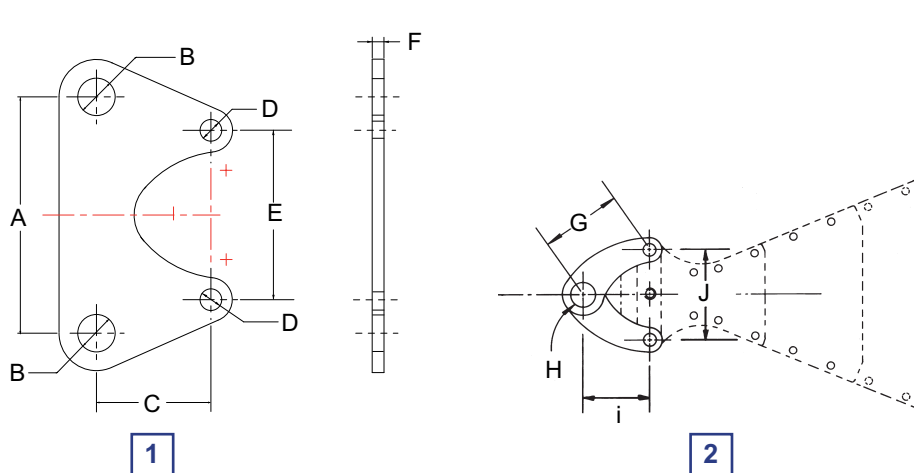

[1] Normally used in pairs as shown here. Mount to burner assembly at any joint.

Dimensions in mm unless stated otherwise									
A	∅ B	C	∅ D	E	F	G	∅ H	I	J
120	19	58	11	86	3	76	19	63	86

Electrical feed through

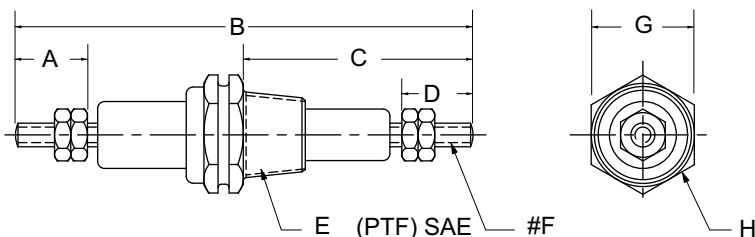

Dimensions in mm unless stated otherwise							
A	B	C	D	E	#F	G	H (wrench size)
12,7	91	46,6	12,7	3/8 -18	10-24	20,6	21

Rubber cover

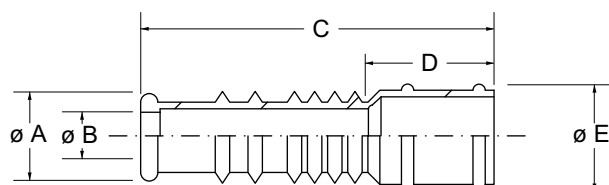

Dimensions in mm unless stated otherwise				
∅ A	∅ B	C	D	∅ E
16	6,5	58	20	18

External mounting assembly

Frequently used to provide easy accessibility to spark ignitor and flame supervision components.

- 1) Includes mounting plate with 2 feed-through insulators for internal mounting of spark ignitor and flame rod
- 2) External mounting plate
- 3) Used with typical pilot
 - x) spark ignitor
 - y) flame rod
- 4) Opening required

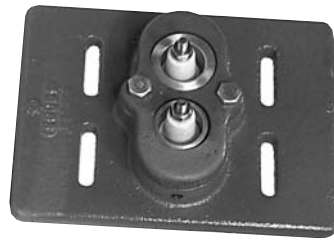

1

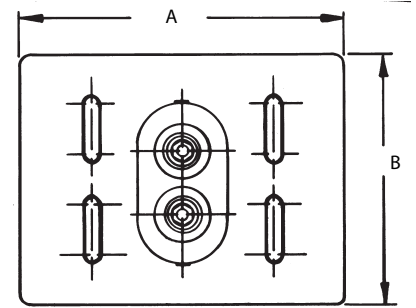

2

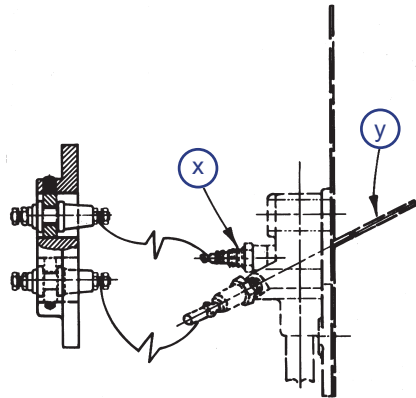

3

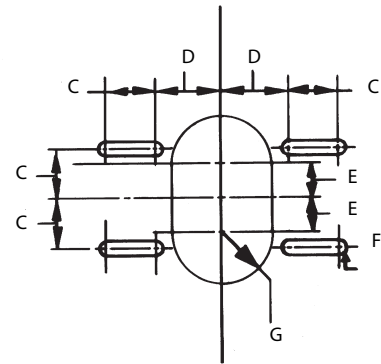

4

Dimensions in mm unless stated otherwise						
A	B	C	D	E	F Ø	G Ø
165	122	25,4	33	17,5	4	25,4

Installation and operating instructions

Application requirements

View port

A view port to observe burner flame is essential to inspect flame aspect. It is recommended to locate the view port downstream of the flame, such that the entire burner front can be observed, as well as the pilot burner.

Position of the burner in the process flow

Series "NP" and "RG" AIRFLO® burners are used only for heating of fresh air in motion. They should be mounted so as to direct their flames parallel to and in the same direction as the movement of the air (see sketch below).

- 1) Direction of air movement
- 2) Adjustable profile plate
- 3) Fixed profile plate
- 4) Universal support bracket
- 5) Differential pressure switch

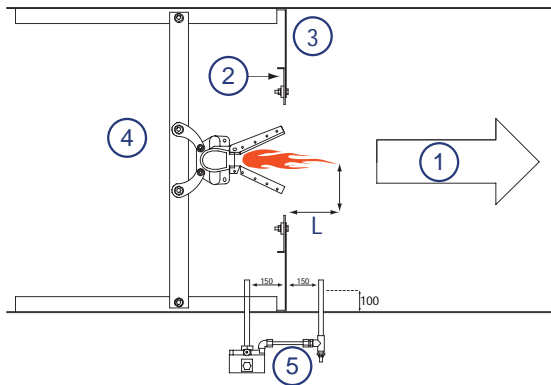

Do not mount the burner so that the movement of air is across the face of the line burner, nor should it be mounted too near to a turn in the duct which may cause air to be directed at an angle over the burner.

Velocity and flow of air at operating temperature must be uniform and not less than specified for the application (refer to diagrams on page 4-21.5-7 and page 4-21.5-8).

Drilling identification

- 1) **NP-I & RG-IV** drillings
d = ø 2 mm

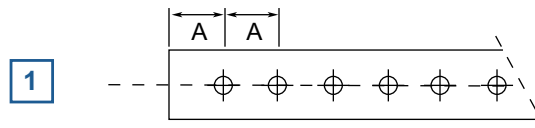

- 2) **NP-II** drillings
d = ø 1,8 mm

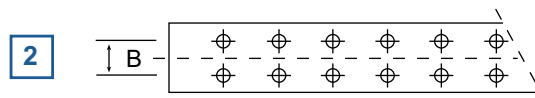

- 3) **NP-III** drillings
d = ø 2 mm

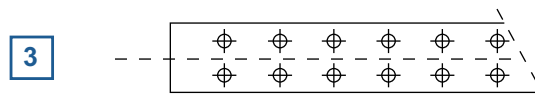

- 4) = 9,5 mm

- 5) = 6,4 mm

Installation

Storage

Series "NP" AIRFLO® and "RG" AIRFLO® burners should be stored dry (inside).

Do not discard packing material until all loose items are accounted for.

Handling

Series "NP" AIRFLO® and "RG" AIRFLO® burners may be shipped as complete burners, as well as in different burner parts.

Handle burners with care during transport, unpacking, lifting and installation.

Avoid bending or damaging the stainless steel mixing plates.

Use proper equipment. Any impact on the burner could result in damage.

Contact MAXON in case of questions.

Assembly instructions for burners divided into sections

Generally, the burners will be supplied as complete pre-assembled units. In some cases however, the burner may be shipped as sub-assemblies, single sections may be supplied loose for shipping convenience (access of burner into the duct), or extra units of burner have been purchased to increase/ modify the capacity/ shape of the existing burner or as replacement items etc.

Follow the assembly instructions below. In case of doubt, please contact MAXON for assistance.

Before being reassembled the burner should be brought to the point of use. There, the burner should be arranged on the floor, mixing plates down, in the intended form. Reassemble as follows

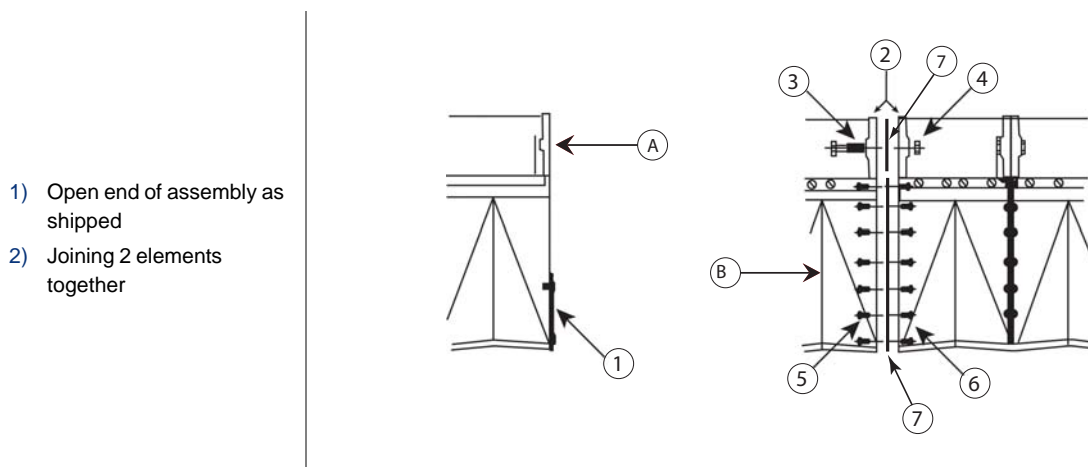

- 1) Open end of assembly as shipped
- 2) Joining 2 elements together

- Study the above sketch to become familiar with the parts and reference letters.
- Check the supply of gaskets, bolts and nuts attached to the crate.
- Remove the protective shipping end plates (1).
- Add support brackets, if any.
- Bring ends of burner sections together, insert gaskets and bolts, and loosely assemble nuts (4) to bolts (3) (2x).
- Insert and assemble bolts (5), and nuts (6), snug but not tight. (5 each side for "NP" AIRFLO®, 7 each side for "RG" AIRFLO®).
- Tighten burner bolts (3), but ensure burner sections do not slip.
Recommended torque bolt and nuts : $3/8-16 \times 1.1/2 = 55 \text{ Nm}$.
- Tighten screws (4), keeping mixing plate gaskets (7) properly aligned.
- Examine all joints to ensure that sealing is complete.

Supporting the burner

Series "NP" AIRFLO® and "RG" AIRFLO® burner assemblies must be adequately supported and positioned.

Avoid rigid mounting. Burner assembly expands and contracts with temperature variations.

Maintain smooth, even air flow over the burner by designing supports to provide minimum interference, deflection and turbulence.

The sketches below show typical installation and support methods:

- 1) Strap iron frame
- 2) MAXON support bracket
- 3) Air movement
- 4) Bolt or rod (long enough to permit brackets to move)
- 5) Allow space for burner expansion
- 6) Angle iron support
- 7) Strap iron frame
- 8) Strap iron to top of duct
- 9) Gas inlet
- 10) Strap iron brace to side of duct
- 11) Gas manifold independently supported
- 12) Strap iron to top of duct
- 13) Ends free to move
- 14) Strap iron to bottom of duct
- 15) Oversize U-bolt drawn up loosely
- 16) Angle iron support
- 17) Rod
- 18) Turn-buckle
- 19) Support brackets
- 20) 3/4" hole
- 21) Strap iron frame
- 22) Bolt or rod (long enough to permit brackets to move)
- 23) Support brackets

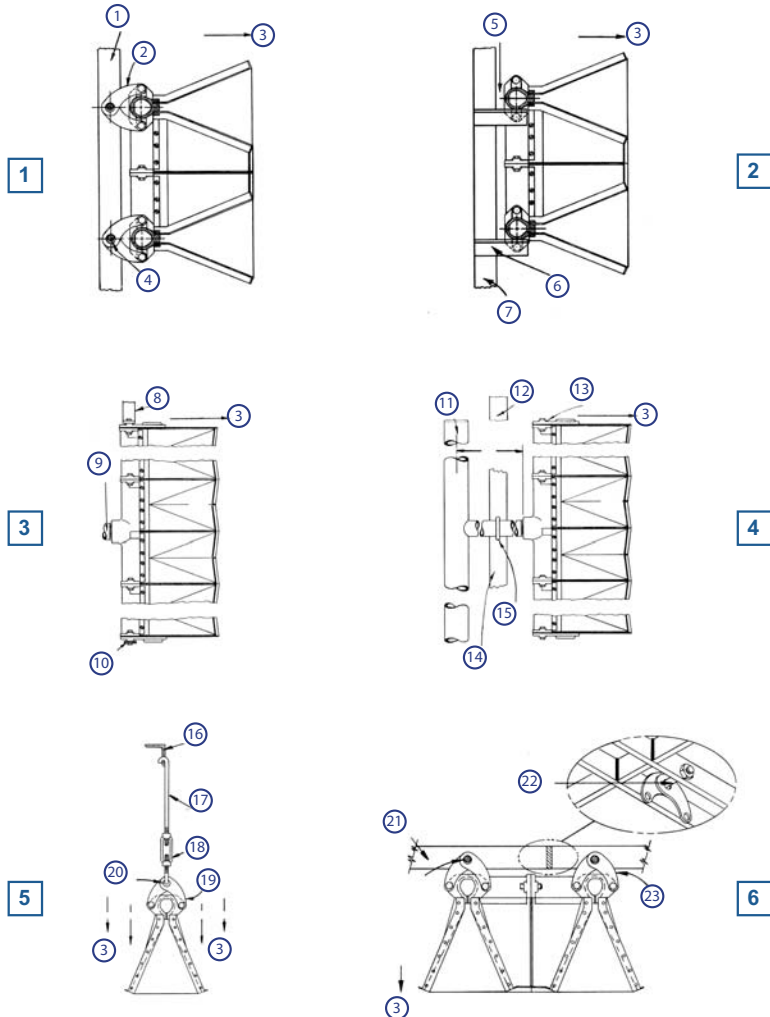

Sketch 1 shows the burner suspended from a strap iron frame using MAXON USB support brackets. Note that rigid mounting is avoided by the bracket hole which slips loosely over a bolt or steel rod attached to the support. Gas piping would need independent support.

Sketch 2 shows the burner assembly resting upon angle iron brackets and not attached to them in any way. Be sure the angle iron supports allow the burner flanges to expand and contract. Gas manifolding would be independently supported and prevent forward movement of the burner.

Sketch 3 shows simple strap iron used to support the burner. Note that narrow edge of strap faces air flow to avoid undue turbulence.

Sketch 4 shows gas manifolding used to support the burner. If there are multiple inlets, you must avoid rigid connection by using the oversize U-bolt (loosely drawn up) illustrated.

Support for down-fired burners can be accomplished as shown in the illustration above. Always avoid rigid mounting.

Sketch 5 shows MAXON USB support brackets suspending the burner from an overhead angle iron.

Sketch 6 shows an alternate arrangement which offers the advantage of more controlled positioning.

W W W . M A X O N C O R P . C O M

COMBUSTION SYSTEMS FOR INDUSTRY

MAXON reserves the right to alter specifications and data without prior notice.
© 2010 Copyright Maxon Corporation. All rights reserved.

MAXON
A Honeywell Company

Start-up instructions

Instructions provided by the company or individual responsible for the manufacture and/or overall installation of a complete system incorporating MAXON burners take precedence over the installation and operating instructions provided by MAXON. If any of the instructions provided by MAXON are in conflict with local codes or regulations, please contact MAXON before initial start-up of equipment.



Read the combustion system manual carefully before initiating the start-up and adjustment procedure. Verify that all of the equipment associated with and necessary to the safe operation of the burner system has been installed correctly, that all pre-commissioning checks have been carried out successfully and that all safety related aspects of the installation are properly addressed.

Initial adjustment and light-off should be undertaken only by a trained commissioning engineer.

First firing or restart after shut-down

Before start-up, or after a longer period shut-down, integrity of the system should be checked by an authorized combustion engineer. Besides the general mechanical installation of burner and piping (rigidity, flanged and threaded connections, tightness of piping and burner body), it is advised to check the condition of mixing plates and burner body drillings.

Check all bolted connections of the burner after first firing (first time on temperature) and retighten if necessary.

Check of safety interlocks



Guarantee that all the required safety locks as described in the applicable local codes or regulations, or extra requested for safe operation of the overall installation are working properly and resulting in a positive safety-lock of the burner. Do not bypass any of these safety interlocks. This will result in unsafe conditions.

Process air flow

Series "NP" and "RG" AIRFLO® burners are raw gas burners. This means that the required oxygen for combustion is drawn from the available process air flow across the burner.

A correct fresh air flow across the burner is essential for safe operation of the burner, and should be safeguarded by a safety-interlock (pressure switch or flow switch) as described in the applicable local codes or regulations.

Refer to "Specifications of "NP" & "RG" AIRFLO® burners" on page 4-21.5-7 for more details or contact MAXON if you require further support.

Pilot ignition

Adjust pilot gas regulator to correct set point before pilot ignition attempt. Turn adjustable orifice screw out (counter-clockwise) several turns from its fully seated position. Refine during lighting of the pilot to a hard, blue flame and/or strongest stable flame signal.

Main burner ignition

Adjust the main gas regulator at the correct set-point before igniting the main burner. Ensure that the control valve is in the start-position when lighting the main burner.

Note that operating characteristics of some regulators may require additional adjustment while firing the burner. Ensure operating pressure to the burner under operating conditions matches those shown on page 4-21.5-7, page 4-21.5-8 and page 4-21.5-9.

Minimum capacity and cross-ignition

Adjust the minimum burner capacity while carefully observing the flame. Ensure that the flame remains stable over the entire burner front.

The minimum capacity of the burner may be influenced by the process air distribution across the burner, the air stream velocity and the position (distribution) and number of gas inlets of the burner.

If the burner is ignited at minimum capacity, verify (by several repeats) that the flame is smoothly cross-igniting over the entire burner front.

Ratio adjustment

Slightly open the gas control valve while observing the flame. Especially observe that the flame is well divided over the entire burner surface, and going straight forward in the direction of the process air flow. Check that no damage is caused to duct-walls, filters, blowers etc.

Limit the min. and max. position in a safe way to guarantee stable flame over the entire burner front at min. position, and to protect the burner for overfiring at max. position.

Flame supervision

Only use the standard connections provided on the end plates for correct flame safeguarding. Use proper flame detection equipment (flame rod or UV scanner).

Refer to the local codes and regulations to determine the number of flame sensors and their position. Be advised that some codes may require proving of cross-ignition by sensing flame on both ends of long burners.

Maintenance and inspection

Safety requirements

Regular inspection, testing and recalibration of combustion equipment according to the installation’s manual is an integral part of its safety. Inspection activities and frequencies shall be carried out as required by the local codes or regulations, and as specified by the overall installation user-manual.

Visual inspections

Regular visual inspection of all connections (gas manifold, bolting of the burner into the duct, condition of profile plate, burner mixing plates and burner body drillings) and burner flame shape and aspect are essential for safe operation.

Recommended spare parts

Keep local stock of spark ignitor and flame sensor. For other spare parts, please refer to the component identification page 4-21.5-33 and page 4-21.5-34. For assistance with parts, please contact MAXON.

Maintenance and component identification Series "NP" AIRFLO® burners

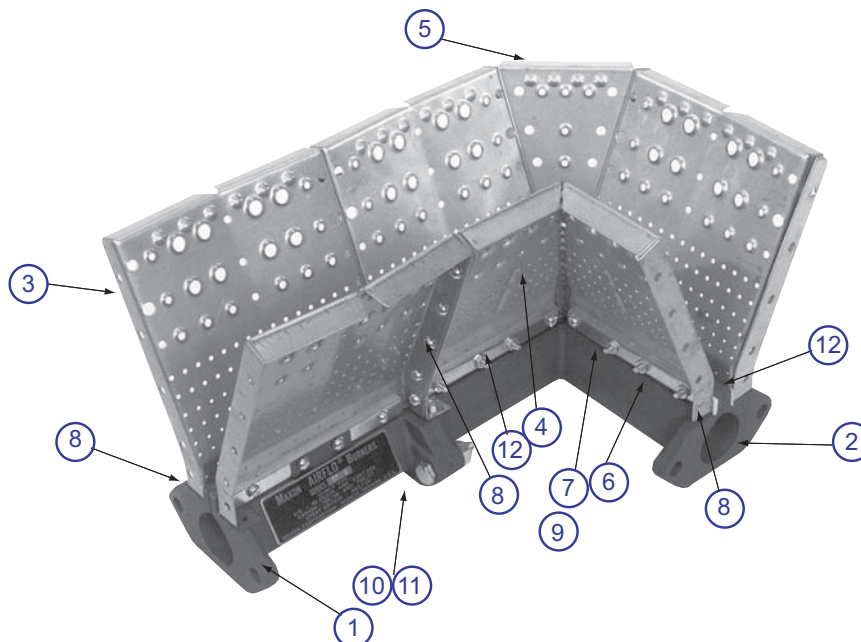

Item n°	Part description	NP-I	NP-II	NP-III	Designation		
		Cast iron bodies with AISI 430 mixing plates and carbon steel fasteners			NP-I	NP-I	
						Alu bodies with AISI 321 mixing plates and carbon steel fasteners	Alu bodies with AISI 321 mixing plates and stainless steel fasteners
1	Burner body	150 mm straight section	NP-I-6	NP-II-6	NP-III-6	NP-I-6 (AL)	NP-I-6 (ALSS)
		305 mm straight section	NP-I-12	NP-II-12	NP-III-12	NP-I-12 (AL)	NP-I-12 (ALSS)
		455 mm straight section	NP-I-18	NP-II-18	NP-III-18	-	-
		610 mm straight section	NP-I-24	NP-II-24	NP-III-24	-	-
		305 mm back inlet section	NP-I-12B	NP-II-12B	NP-III-12B	NP-I-12B (AL)	NP-I-12B (ALSS)
		36 in. back inlet section	NP-I-36B	NP-II-36B	NP-III-36B	N/A	N/A
		305 mm x 150 mm T-section	NP-I-T	NP-II-T	NP-III-T	NP-I-T (AL)	NP-I-T (ALSS)
2	Burner body	150 mm x 150 mm elbow section	NP-I-L	NP-II-L	NP-III-L	-	-

Item n°	Part description	Designation	Quantity required for indicated section						
			6" str.	12" str.	18" str.	24" str.	12"x6" Tee	6"x6" elbow	12" B.I.
3	Mixing plate	6" MIXING PLATE NP SS430	2	4	6	8	2	2	4
4	Mixing plate : inside corner	INS.CORNER MIXING PLATE 430 SS	-	-	-	-	2	1	-
5	Mixing plate : wedge	MIXING PLATE WEDGE SS 430	-	-	-	-	-	1	-
6	back up bar	BACK UP BAR 'OUTSIDE' FOR NP	2	4	6	8	2	2	4
7	#10-24 x 1-3/8" round head mach. screw "Sems"	SCR.RD SEMS PLTD 10-24X1-3/8	4	8	12	16	12	8	8
8	#10-24 x 1/2" round head mach. screw "Sems"	MACH.SCREW SEMS 10-24X1/2	12	24	36	48	29	22	24
9	#10-24 hex nut	NUT 10-24 ZINC PLATED	14	28	42	56	37	28	28
10	3/8"-16 z 1-1/2" hex head cap screw	HEX HD CAP SCR.3/8-16X1-1/2 PL	2	2	2	2	4	2	2
11	3/8"-16 hex nut	HEX NUT 3/8-16 ZINC PLATED	2	2	2	2	4	2	2
12	back up bar (inside)	BACK UP BAR 'INSIDE' FOR NP	-	-	-	-	4	2	-

Maintenance and component identification Series "RG" AIRFLO® burners

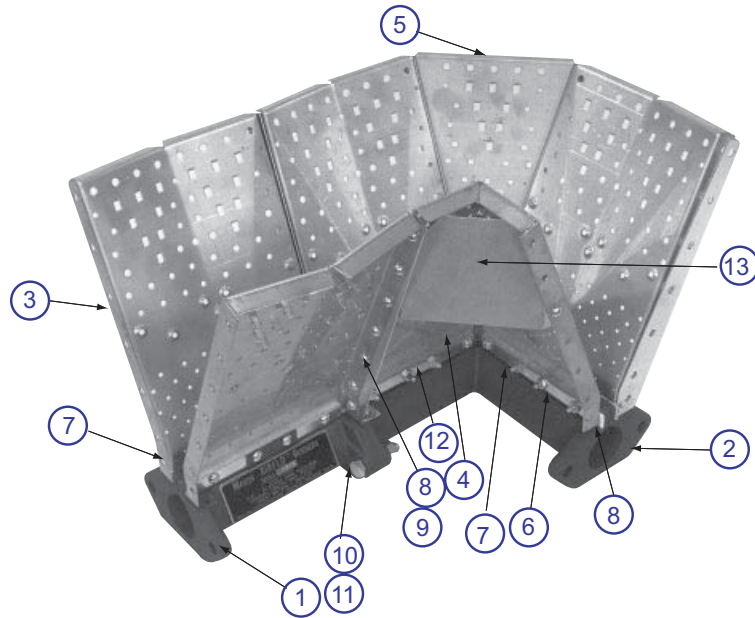

Item n°	Part description	RG-IV	RG-IV	RG-IV	
		Cast iron bodies with AISI 430 mixing plates and carbon steel fasteners	Alu bodies with AISI 321 mixing plates and carbon steel fasteners	Alu bodies with AISI 321 mixing plates and stainless steel fasteners	
		Designation			
1	Burner body	150 mm straight section	RG-IV-6	RG-IV-6 (AL)	RG-IV-6 (ALSS)
		305 mm straight section	RG-IV-12	RG-IV-12 (AL)	RG-IV-12 (ALSS)
		455 mm straight section	RG-IV-18	-	-
		610 mm straight section	RG-IV-24	-	-
		305 mm back inlet section	RG-IV-12	-	-
		36 in. back inlet section	RG-IV-36	N/A	N/A
		305 mm x 150 mm T-section	RG-IV-T	RG-IV-T (AL)	RG-IV-T (ALSS)
2	Burner body	150 mm x 150 mm elbow section	RG-IV-L	RG-IV-L (AL)	RG-IV-L (ALSS)

Item n°	Part description	Designation	Quantity required for indicated section						
			6" str.	12" str.	18" str.	24" str.	12"x6" Tee	6"x6" elbow	12" B.I.
3	Mixing plate	6" MIXING PLATE STRAIGHT RG	2	4	6	8	2	2	4
4	Mixing plate : inside corner	INSIDE CORNER MIX.PLATE-RG-IV	-	-	-	-	2	1	-
5	Mixing plate : wedge	MIXING PLATE 'WEDGE'	-	-	-	-	-	1	-
6	back up bar	BACK UP BAR 'OUTSIDE' FOR RG	2	4	6	8	2	2	4
7	#10-24 x 1-3/8" round head mach. screw "Sems"	SCR.RD SEMS PLTD 10-24X1-3/8	4	8	12	16	12	8	8
8	#10-24 x 1/2" round head mach. screw "Sems"	MACH.SCREW SEMS 10-24X1/2	16	32	48	64	39	30	32
9	#10-24 hex nut	NUT 10-24 ZINC PLATED	18	36	54	72	47	36	36
10	3/8"-16 z 1-1/2" hex head cap screw	HEX HD CAP SCR.3/8-16X1-1/2 PL	2	2	2	2	4	2	2
11	3/8"-16 hex nut	HEX NUT 3/8-16 ZINC PLATED	2	2	2	2	4	2	2
12	back up bar (inside)	BACK UP BAR 'INSIDE' FOR RG	-	-	-	-	4	2	-
13	deflector plate	DEFLECTOR PLATE AL STL	-	-	-	-	2	1	-