

RS/1 SERIES

The RS/1 series of burners covers a firing range from 70 to 550 kW, and they have been designed for use in low or medium temperature hot water boilers, hot air or steam boilers, diathermic oil boilers.

Operation is "one stage"; the burners are fitted with a microprocessor-based burner safety control box which supplies indication of operation and diagnosis of fault cause. Optimisation of sound emissions is guaranteed by the special design of the air suction circuit.

The elevated performance of the fans and combustion head, guarantee flexibility of use and excellent working at all firing rates.

The exclusive design ensures reduced dimensions, simple use and maintenance. Optimisation of sound emissions is guaranteed by the special design of the air suction circuit and by incorporated sound proofing material. A wide range of accessories guarantees elevated working flexibility.



RS 34/1 MZ	70 ÷ 390 kW
RS 44/1 MZ	100 ÷ 550 kW

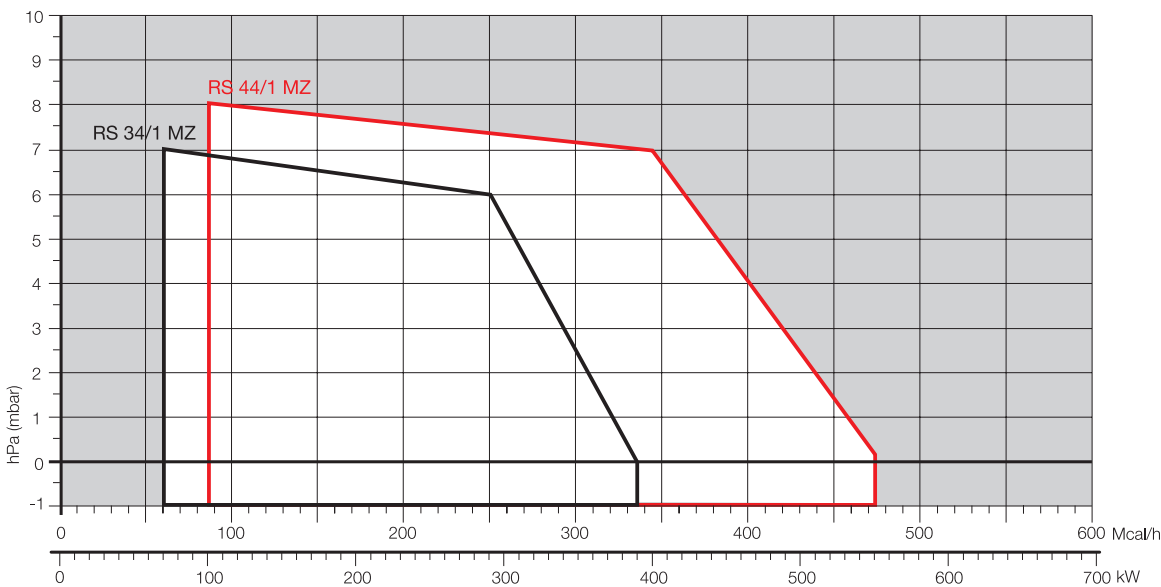

 Useful working field for choosing the burner

Test conditions conforming to EN676
 Temperature: 20°C
 Pressure: 1013,5 mbar
 Altitude: 0 m a.s.l.

One Stage Gas Burners

RS/1 SERIES

Overall dimensions (mm)

BURNER

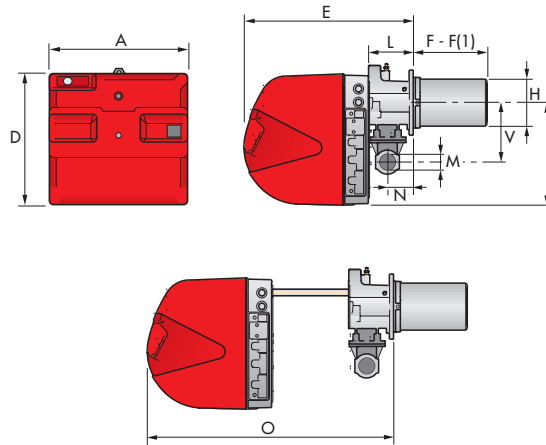

MODEL	A	D	E	F - F(1)	H	I	L	M	N	O	S	V
▶ RS 34/1 MZ	442	422	508	216 - 351	140	305	138	1 1/2	84	780	-	177
▶ RS 44/1 MZ	442	422	508	216 - 351	152	305	138	1 1/2	84	780	-	177

(1) dimension with extended head

BURNER - BOILER MOUNTING FLANGE

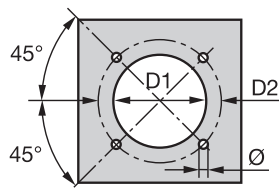

MODEL	D1	D2	Ø
▶ RS 34/1 MZ	160	224	M8
▶ RS 44/1 MZ	160	224	M8

PACKAGING

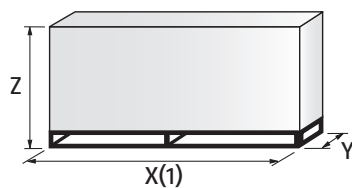

MODEL	X (1)	Y	Z	kg
▶ RS 34/1 MZ	1000	485	500	32
▶ RS 44/1 MZ	1000	485	500	33

(1) dimension with standard and extended head

Specification

DESIGNATION OF SERIES

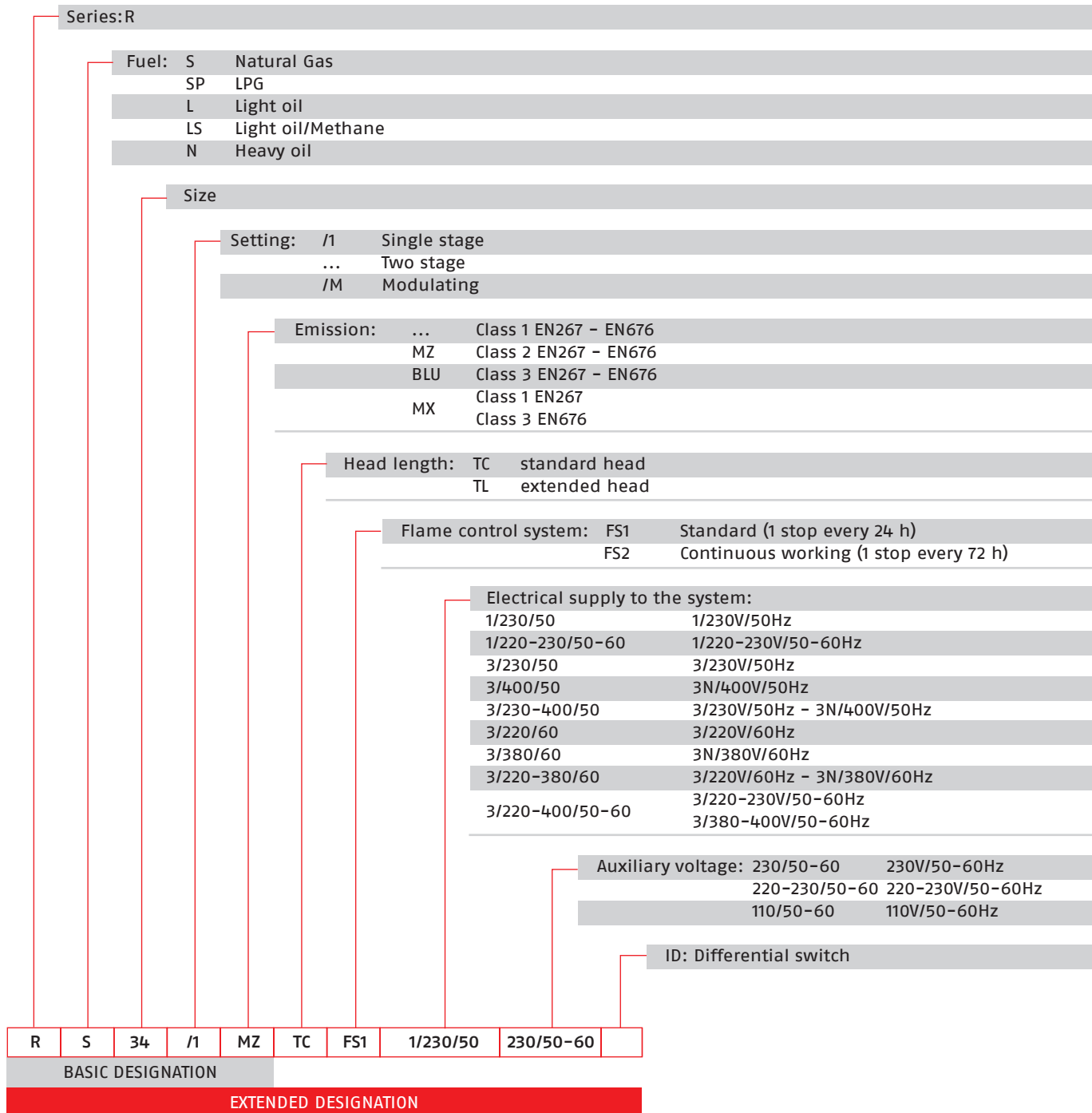

One Stage Gas Burners

RS/1 SERIES

Specification

STATE OF SUPPLY

Monoblock forced draught gas burner with one stage operation, fully automatic, made up of:

- Air suction circuit with sound proofing material
- High performance fan with straight blades
- Air damper for air flow setting
- Starting motor at 2800 rpm, single-phase / 220-230V / 50-60Hz
- Combustion head, that can be set on the basis of required output, fitted with:
 - stainless steel end cone, resistant to corrosion and high temperatures
 - ignition electrodes
 - ionisation probe
 - gas distributor
 - flame stability disk
- Minimum air pressure switch stops the burner in case of insufficient air quantity at the combustion head
- Microprocessor-based burner safety control box, with diagnostic functions
- Plug and socket for electrical connections accessible from the external of the cover
- Flame inspection window
- Slide bars for easier installation and maintenance
- Protection filter against radio interference
- IP X0D (IP 40) electric protection level.

Standard equipment:

- 1 gas train flange
- 1 flange gasket
- 4 screws for fixing the flange
- 1 thermal screen
- 4 screws for fixing the burner flange to the boiler
- 3 plugs for electrical connection
- Instruction handbook for installation, use and maintenance
- Spare parts catalogue.

Available models

Burners

CODE	MODEL	HEAT OUTPUT NATURAL GAS		TOTAL ELECTRICAL POWER	CERTIFICATION	NOTE
		(kW)	(Nm ³ /h)	(kW)		
3788510	RS 34/1 MZ TC FS1 1/230/50-60 230/50-60	70-390	7-39	0,6	CE0085BR0380	
3788511	RS 34/1 MZ TL FS1 1/230/50-60 230/50-60	70-390	7-39	0,6	CE0085BR0380	
3788610	RS 44/1 MZ TC FS1 1/230/50-60 230/50-60	100-550	10-55	0,7	CE0085BR0380	
3788611	RS 44/1 MZ TL FS1 1/230/50-60 230/50-60	100-550	10-55	0,7	CE0085BR0380	

Natural Gas, net calorific value: 10 kWh/Nm³ - Density at 20°C: 0,71 kg/Nm³

The burners of RS/1 series are in according to 2009/142 - 2004/108 - 2006/95 - 2006/42 EC Directive and EN 676 Norm.

RS/1 SERIES

Available models

Gas Trains

CODE	GAS TRAIN			VPS CODE	ADAPTER CODE	
	MODEL	Ø	C.T.		RS 34/1	RS 44/1
3970500*	MB 405/1 - RT 20	Rp 3/4"	-	3010123	3000824	
3970084*	MB 405/2 - RSD 20	Rp 1/2"	-	3010123	20044756	
3970553*	MB 407/1 - RT 20	Rp 3/4"	-	3010123	3000824	
3970599*	MB 407/1 - RT 52	Rp 3/4"	-	3010123		
3970229*	MB 407/1 - RSM 20	Rp 3/4"	-	3010123		
3970537*	MB 407/2 - RSD 20	Rp 3/4"	-	3010123		
3970556*	MB 407/2 - RT 20	Rp 3/4"	-	3010123		
3970258*	MB 410/1 - RT 52	Rp 1" 1/4	-	3010123	3010124	3010124
3970554*	MB 410/1 - RT 20	Rp 3/4"	-	3010123	3000824	
3970600*	MB 410/1 - RT 52	Rp 3/4"	-	3010123		
3970230*	MB 410/1 - RSM 20	Rp 3/4"	-	3010123		
3970534*	MB 410/2 - RSD 20	Rp 3/4"	-	3010123		
3970557*	MB 410/2 - RT 20	Rp 3/4"	-	3010123		
3970256*	MB 412/1 - RT 52	Rp 1" 1/2	-	3010123	-	-
3970144*	MB 412/1 - RT 20	Rp 1" 1/2	-	3010123	-	-
3970197**	MB 412/1 CT RT 20	Rp 1" 1/2	◆	-	-	-
3970231*	MB 412/1 - RSM 20	Rp 1" 1/2	-	3010123	-	-
3970152*	MB 412/2 - RT 20	Rp 1" 1/2	-	3010123	-	-
3970180*	MB 415/1 - RT 30	Rp 1" 1/2	-	3010123	-	-
3970198**	MB 415/1 CT RT 30	Rp 1" 1/2	◆	-	-	-
3970250*	MB 415/1 - RT 52	Rp 1" 1/2	-	3010123	-	-
3970253**	MB 415/1 CT RT 52	Rp 1" 1/2	◆	-	-	-
3970232*	MB 415/1 - RSM 30	Rp 1" 1/2	-	3010123	-	-
3970183*	MB 415/2 - RT 20	Rp 1" 1/2	-	3010123	-	-
3970181*	MB 420/1 - RT 30	Rp 2"	-	3010123	3000822	
3970182**	MB 420/1 CT RT 30	Rp 2"	◆	-		
3970257*	MB 420/1 - RT 52	Rp 2"	-	3010123		
3970252**	MB 420/1 CT RT 52	Rp 2"	◆	-		
3970233*	MB 420/1 - RSM 30	Rp 2"	-	3010123		
3970234**	MB 420/1 CT RSM 30	Rp 2"	◆	-	3000822	
3970184*	MB 420/2 - RT 20	Rp 2"	-	3010123		
3970185**	MB 420/2 CT RT 20	Rp 2"	◆	-		
3970221*	MBC 1200/1 - RSM 60	Rp 2"	-	3010367		
3970225**	MBC 1200/1 CT RSM 60	Rp 2"	◆	-		
3970222*	MBC 1900/1 - FSM 40	DN 65	-	3010367	●	●
3970226**	MBC 1900/1 CT FSM 40	DN 65	◆	-	●	●
3970223*	MBC 3100/1 - FSM 40	DN 80	-	3010367	●	●
3970227**	MBC 3100/1 CT FSM 40	DN 80	◆	-	●	●

Please see designation of Gas Train Series in the page before the Catalogue index.

* 230V/50Hz -220V/60Hz electrical supply.

** 230V/50Hz electrical supply.

The valve seal control device is compulsory (conforming to EN 676) on gas trains to burners with a maximum output over 1200 kW.

The seal control function is managed by LMV control box, by installation on gas train of pressure switch supplied, as standard equipment, with the burner.

To select the gas train please refer to the technical data leaflet and/or instruction manual.

C.T. Gas valve leak detection control device:

- gas train not equipped with leak detection control device; this device can be ordered separately - see VPS column - and installed later.

◆ gas train equipped with leak detection control device.

VPS Valve leak detection control device. Supplied separately from the gas train (please see Gas train accessories paragraph for both 50 Hz and 60 Hz codes).

● Not available.

One Stage Gas Burners

RS/1 SERIES

Available models

Gas Trains

CODE	GAS TRAIN			VPS CODE	ADAPTER CODE			
	MODEL	Ø	C.T.		RS 34/1	RS 44/1		
3970145*	CB 512/1 - RSM 30	Rp 1" ½	-	3010367	-	-		
20045589**	CB 512/1 CT RSM 30	Rp 1" ½	◆	-	-	-		
3970153*	CB 512/2 - RT 32	Rp 1" ½	-	3010367	-	-		
20045590**	CB 512/2 CT RT 32	Rp 1" ½	◆	-	-	-		
3970146*	CB 520/1 - RSM 30	Rp 2"	-	3010367	3000822			
3970160**	CB 520/1 CT RSM 30	Rp 2"	◆	-				
3970154*	CB 520/2 - RT 32	Rp 2"	-	3010367				
20045591**	CB 520/2 CT RT 32	Rp 2"	◆	-				
20044659*	CB 525/1 - RSM 30	Rp 2"	-	3010367				
20044660**	CB 525/1 CT RSM 30	Rp 2"	◆	-				
3970147*	CB 5065/1 - FSM 30	DN 65	-	3010367			●	3000825
3970161**	CB 5065/1 CT FSM 30	DN 65	◆	-			●	
3970155*	CB 5065/2 - FT 32	DN 65	-	3010367	●			
3970167**	CB 5065/2 CT FT 32	DN 65	◆	-	●			
3970148*	CB 5080/1 - FSM 30	DN 80	-	3010367	●	●		
3970162**	CB 5080/1 CT FSM 30	DN 80	◆	-	●	●		
3970149*	CB 50100/1 - FSM 30	DN 100	-	3010367	●	●		
3970163**	CB 50100/1 CT FSM 30	DN 100	◆	-	●	●		

Please see designation of Gas Train Series in the page before the Catalogue index.

* gas train are 230V/50Hz - 220V/60Hz electrical supply.

The valve seal control device is compulsory (conforming to EN 676) on gas trains to burners with a maximum output over 1200 kW.

To select the gas train please refer to the technical data leaflet and/or instruction manual.

C.T. Gas valve leak detection control device:

- gas train not equipped with leak detection control device; this device can be ordered separately - see VPS column - and installed later.

◆ gas train equipped with leak detection control device.

VPS Valve leak detection control device. Supplied separately from the gas train (please see Gas train accessories paragraph for both 50 Hz and 60 Hz codes).

● Not available.

Burner accessories

Extended head kit

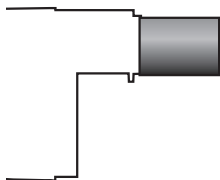

"Standard head" burners can be transformed into "extended head" versions, by using the special kit. The KITS available for the various burners, giving the original and the extended lengths, are listed below.

BURNER	'STANDARD HEAD' LENGTH (mm)	'EXTENDED HEAD' LENGTH (mm)	KIT CODE
▶ RS 34/1 MZ	216	351	3010428
▶ RS 44/1 MZ	216	351	3010429

Spacer kit

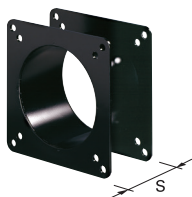

If burner head penetration into the combustion chamber needs reducing, varying thickness spacers are available, as given in the following table:

BURNER	SPACER THICKNESS S (mm)	KIT CODE
▶ RS 34/1 MZ - 44/1 MZ	110	3010095

Post-ventilation kit

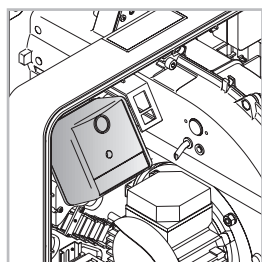

To prolong ventilation for approximately 20 seconds after opening of thermostats chain, a special kit is available.

BURNER	KIT CODE
▶ RS 34/1 MZ - 44/1 MZ	3010452

Continuous ventilation kit



If the burner requires continuous ventilation in the stages without flame, a special kit is available as given in the following table:

BURNER	KIT CODE
▶ RS 34/1 MZ - 44/1 MZ	3010449

One Stage Gas Burners

RS/1 SERIES

Burner accessories

Sound proofing box

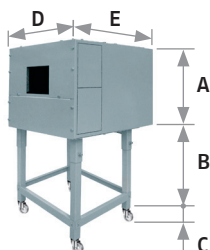

If noise emission needs reducing even further, sound-proofing boxes are available. In case of generator heights, where a lower dimension "B" is required, ask for the Box Support Kit code 20065135. The useful dimensions are 40 mm less than the total dimensions indicated in the table (A, D, E). Not suitable for outdoor use.

BURNER	BOX TYPE	A (mm)	B (mm) min-max	C (mm)	D (mm)	E (mm)	[dB(A)] (*)	BOX CODE
▶ RS 34/1 MZ RS 44/1 MZ	C1/3	650	372 - 980	110	690	770	10	3010403

(*) Average noise reduction according to EN 15036-1 standard

LPG kit



For burning LPG gas, a special kit is available to be fitted to the combustion head on the burner, as given in the following table:

BURNER	KIT CODE
▶ RS 34/1 MZ	3010423
▶ RS 44/1 MZ	3010424

Town gas kit



For burning Town gas, a special kit is available:

BURNER	KIT CODE FOR 'STANDARD HEAD' (*)	KIT CODE FOR 'EXTENDED HEAD' (*)
▶ RS 34/1 MZ	3010502	3010502
▶ RS 44/1 MZ	3010503	3010503

(*) Without CE certification

Hours counter kit

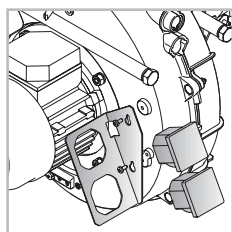

To measure the burner working time a hours counter kit is available.

BURNER	KIT CODE
▶ RS 34/1 MZ - 44/1 MZ	3010450

Ground fault interrupter kit



A "Ground fault interrupter kit" is available as a safety device for electrical system fault.

BURNER	KIT CODE
▶ RS 34/1 MZ - 44/1 MZ	3010448

Burner accessories

Gas max pressure switch

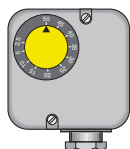

If necessary a Gas max pressure Switch kit is available and connectable to the burner electrical wiring through Plugs & Sockets system.

BURNER	KIT CODE
► RS 34/1 MZ - 44/1 MZ	3010418

Volt free contact kit



A volt free contact kit is available for installation onto the burner. It can be used for a remote interface between burner operating signals. Every burner can be equipped with a single kit for a remote check of the flame presence signal and the burner lock-out indication.

BURNER	KIT CODE
► RS 34/1 MZ - 44/1 MZ	3010419

PC interface kit



To connect the control box to a personal computer for the transmission of operation, fault signals and detailed service information, an interface adapter with PC software are available.

BURNER	KIT CODE
► RS 34/1 MZ - 44/1 MZ	3002719

Protection kit (electromagnetic interferences)

When the burner is installed in a room particularly subject to electromagnetic interference (signals emitted over 10 V/m) due for example to INVERTER presence or in systems where the lengths of the thermostat connections is over 20 meters, this specific protection kit is available as an interface between the thermostatic controls and the burner.

BURNER	KIT CODE
► All models	3010386





One Stage Gas Burners

RS/1 SERIES

Gas train accessories

Adapters

In certain cases, an adapter must be fitted between the gas train and the burner, when the diameter of the gas train is different from the set diameter of the burner. Below are given the available adapters; please see on the Gas Train list the correct adapter codes to select.

ADAPTER	LENGTH mm	ADAPTER CODE
2"  1" 1/2	70	3000822
3/4"  1" 1/2	31	3000824
1/2"  1" 1/2	31	20044756
1" 1/4"  1" 1/2	35	3010124
1" 1/4"  2"	35	3010126

Seal control kit



To test the valve seals on the gas train, a special "seal control kit" is available. The valve seal control device is compulsory (EN 676) on gas trains to burners with a maximum output over 1200 kW. The sealing control is type VPS 504.

GAS TRAIN	KIT CODE for 50 Hz operation	KIT CODE for 60 Hz operation
▶ MB 405/1 – MB 407/1 – MB 407/2 – MB 410/1 – MB 410/2 MB 412/1 – MB 412/2 – MB 415/1 – CB 512/1	3010123	20050030
▶ MB 415/2 – CB 512/2 – MB 420/2 – CB 520/2	3010125	20050033

Stabiliser spring



To vary the pressure range of the gas train stabilisers, accessory springs are available. The following table shows these accessories with their application range. Please refer to the technical manual for the correct choice of spring.

GAS TRAIN	SPRING COLOUR	SPRING PRESSURE RANGE mbar	SPRING CODE
▶ CB 512/1 – 512/2	Red	25 – 55	3010131
	Black	60 – 110	3010157
	Pink	90 – 150	3090486
▶ CB 520/1 – 520/2 – 525/1	Red	25 – 55	3010132
	Black	60 – 110	3010158
	Pink	100 – 150	3090487