

Motorized valve for gas VK

OPERATING INSTRUCTIONS

Cert. Version · Edition 05.22 · EN · 34416200



CONTENTS

1 Safety	1
2 Checking the usage	2
3 Installation	2
4 Wiring	3
5 Tightness test	4
6 Commissioning	4
7 Checking the motor actuator	5
8 Checking the hydraulic system	5
9 Maintenance	5
10 Spare parts	5
11 Converting VK into VK..S or VK..Z..S	6
12 Installing a closed position switch	6
13 Installing two closed position switches	7
14 Technical data	7
15 Designed lifetime	8
16 Certification	8
17 Logistics	9
18 Disposal	9

1 SAFETY

1.1 Please read and keep in a safe place



Please read through these instructions carefully before installing or operating. Following the installation, pass the instructions on to the operator. This unit must be installed and commissioned in accordance with the regulations and standards in force. These instructions can also be found at www.docuthek.com.

1.2 Explanation of symbols

1, 2, 3, a, b, c = Action

→ = Instruction

1.3 Liability

We will not be held liable for damage resulting from non-observance of the instructions and non-compliant use.

1.4 Safety instructions

Information that is relevant for safety is indicated in the instructions as follows:

⚠ DANGER

Indicates potentially fatal situations.

⚠ WARNING

Indicates possible danger to life and limb.

⚠ CAUTION

Indicates possible material damage.

All interventions may only be carried out by qualified gas technicians. Electrical interventions may only be carried out by qualified electricians.

1.5 Conversion, spare parts

All technical changes are prohibited. Only use OEM spare parts.

2 CHECKING THE USAGE

2.1 Intended use

Motorized valve for gas for safeguarding, regulating and controlling air and gas on various appliances.

This function is only guaranteed when used within the specified limits – see page 7 (14 Technical data). Any other use is considered as non-compliant.

Explosion-proof version VK..X, see VK..X, VK..HX operating instructions at www.docuthek.com.

2.2 Type code

VK	Motorized valve for gas
40-250	Nominal size
/100	Reduced to nominal size 100 mm
R	Rp internal thread
F	Flange to ISO 7005
02	p_U max. 230 mbar
04	p_U max. 400 mbar
05	p_U max. 500 mbar
06	p_U max. 600 mbar
10	p_U max. 1 bar
15	p_U max. 1.5 bar
20	p_U max. 2 bar
24	p_U max. 2.4 bar
31	p_U max. 3.1 bar
40	p_U max. 4 bar
60	p_U max. 6 bar
80	p_U max. 8 bar
Z	2-stage
T5	Mains voltage: 220/240 V AC, 50 Hz
T5/K	Mains voltage: 220 V AC, 50 Hz/24 V DC
W5	Mains voltage: 230 V AC, 50 Hz
Q6	Mains voltage: 120 V AC, 60 Hz
W6	Mains voltage: 230 V AC, 60 Hz
M	Mains voltage: 110 V AC, 50/60 Hz
P	Mains voltage 100 V AC, 50/60 Hz
Y	Mains voltage 200 V AC, 50/60 Hz
X	Explosion-proof version, IP 65
H	For higher inlet pressures
A	Valve housing made of AISi
G	Valve housing made of GGG 50 complying with TRD 412 and GUV
4	Terminal connection box, IP 65
6	Connection box with 4-pin standard socket, IP 54
6L	Connection box with 4-pin standard socket, with lamp, IP 54
9	Metal terminal connection box, IP 54
3	Screw plugs at the inlet and outlet
D	With flow adjustment
S	Closed position switch
S2	2 closed position switches
V	With Viton valve plate seal
F	With viewing window

2.3 Part designations

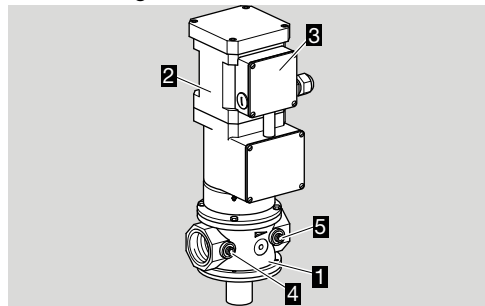

- 1 Housing
- 2 Motor actuator
- 3 Connection box
- 4 Plug for inlet pressure p_U
- 5 Plug for outlet pressure p_d

2.4 Type label

Inlet pressure, mains voltage, electrical power rating, ambient temperature, enclosure and installation position: see type label.

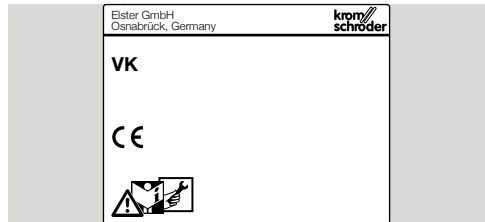

3 INSTALLATION

⚠ CAUTION

Incorrect installation

Please observe the following to ensure that the unit is not damaged during installation and operation:

- Install the unit in the pipe free of mechanical stress.
- Do not clamp the unit in a vice. Only secure the flange by holding the octagon with a suitable spanner. Risk of external leakage.
- Do not use the motor actuator as a lever.
- Sealing material and dirt, e.g. thread cuttings, must not be allowed to get into the valve housing.
- Install a filter upstream of every system.
- Dropping the device can cause permanent damage. In this event, replace the entire device and associated modules before use.
- The unit may only be stored/installed in enclosed rooms/buildings.
- Check max. ambient temperature and max. inlet pressure – see type label.

→ Installation position: motor actuator in the vertical upright position or tilted up to the horizontal,

not upside down. The connection box must point upwards if the device is installed in an "Actuator horizontal" position.

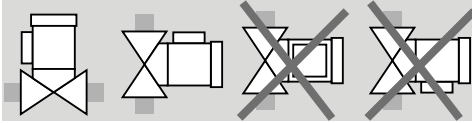

→ The motorized valve for gas VK must not be in contact with masonry. Minimum clearance to the side: 20 mm.

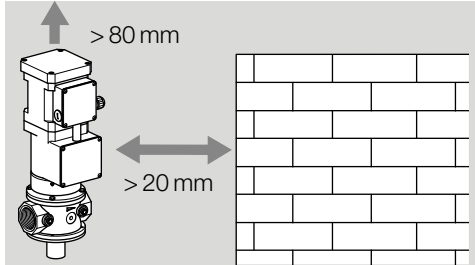

→ Ensure that there is sufficient space for installation and adjustment. Minimum clearance to the top: 80 mm.

→ Use a suitable spanner.

→ The inlet pressure p_u and the outlet pressure p_d can be measured at the appropriate pressure test points.

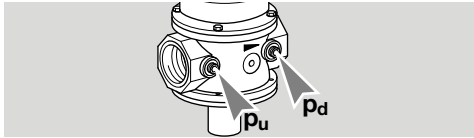

VK..R

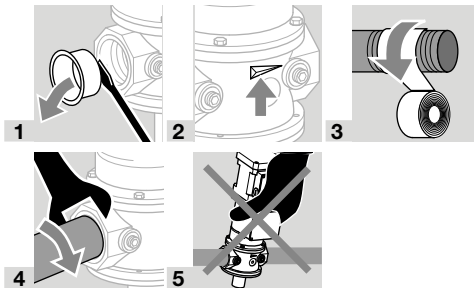

VK..F

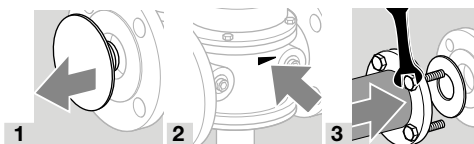

4 WIRING

⚠ WARNING

Risk of injury!

Please observe the following to ensure that no damage occurs:

- Electric shocks can be fatal! Before working on possible live components, ensure the unit is disconnected from the power supply.

→ Use temperature-resistant cable (> 80°C/176°F).

→ Wiring to EN 60204-1.

→ The data on the type label must comply with the mains voltage (tolerance: + 10%, - 15%).

1 Disconnect the system from the electrical power supply. Install a double-pole switch – isolating link fused main switch or fused spur box – with a contact gap of at least 3 mm upstream.

2 Shut off the gas supply.

3 To set the the motor actuator to the correct position, just undo all four nuts and grub screws. Then turn the motor actuator so that the connection box is accessible.

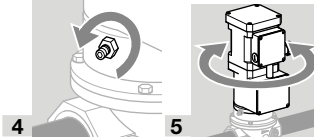

6 Retighten the grub screws and nuts.

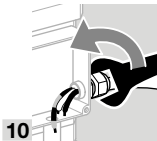
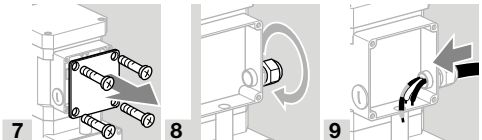

11 Wire as shown on the connection diagram.

Connection diagram

L1 = phase

N = neutral conductor

L_{V1} = phase for the 1st stage

L_{V2} = phase for the 2nd stage

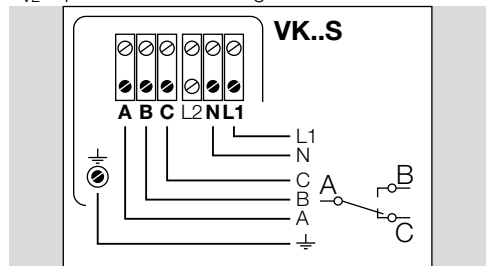

VK..S2

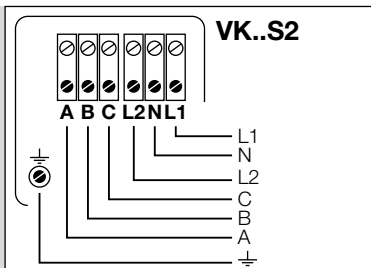

VK..Z..S

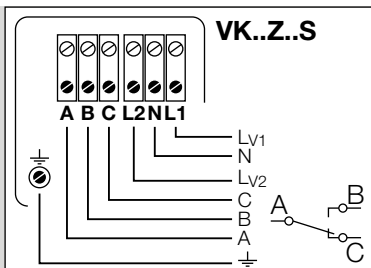

VK..T5/K

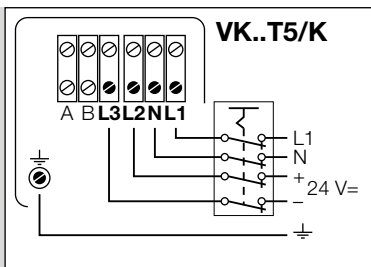

→ On VK..T5/K: in order to close the valve, both power supply points must be switched off.

Finishing the wiring

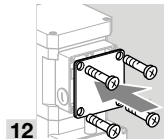

- 12**
- When the electric circuit is open, the valve is closed.
 - When the electric circuit is closed, the valve is open.
 - For two-stage motorized valves: the second stage cannot be set until the first stage has been completed.

5 TIGHTNESS TEST

- 1** Close the motorized valve.
- 2** To be able to check the tightness, shut off the downstream pipeline close to the valve.

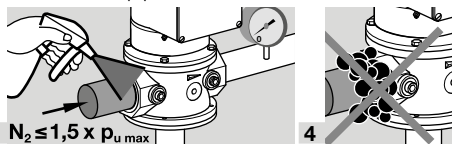

3 $N_2 \leq 1,5 \times p_{u \max}$

4

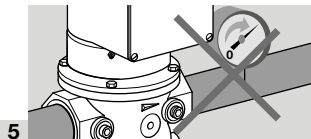

5

- 6** Open the motorized valve.

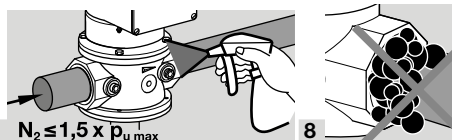

7 $N_2 \leq 1,5 \times p_{u \max}$

8

- 9** Tightness OK: open the pipeline.

→ Pipeline leaking: remove the VK and return it to the manufacturer.

6 COMMISSIONING

Setting the flow rate Q

- Flow rate adjustable up to and including nominal size DN 100.
- At the factory, the motorized valve for gas is adjusted for maximum flow rate.
- Connect a pressure gauge if necessary.
- Measure the pressure upstream of the burner.

- 1** Close the valve. The throughput adjusting screw can be more easily turned.

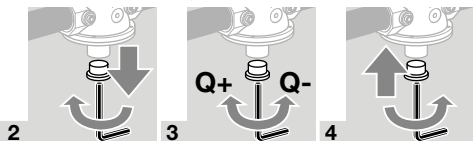

Setting the start gas rate on VK..Z..S and adjusting the closed position switch on VK..Z..S

- 1** Connect a pressure gauge to measure the pressure upstream of the burner.

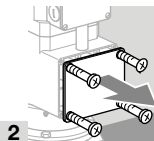

2

VK..Z..S start gas rate

3 Set the burner control unit by hand to the first stage (start gas rate).

→ Set the first stage (start gas rate) on the VK..Z..S as specified by the burner manufacturer using an Allen key.

Clockwise = lower volume.

Anticlockwise = higher volume.

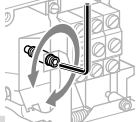

4

VK..S, VK..Z..S closed position switch

→ Factory setting of the closed position switch: valve closed.

→ Adjust the VK with an Allen key until the switch is actuated with the required stroke – on the VK..S to indicate valve position “Closed” or on the VK..Z..S as a stage indicator:

Clockwise = smaller stroke.

Anticlockwise = larger stroke.

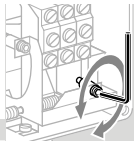

5

Finishing commissioning

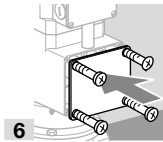

6

7 CHECKING THE MOTOR ACTUATOR

→ The motor actuator must be checked once per year for oil leaks.

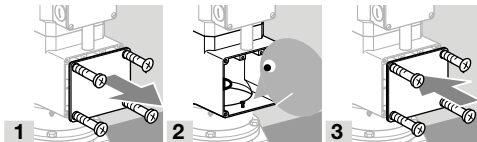

1

2

3

4 If there is oil on the upper housing cover (more than a few drops), remove the motor actuator and send it to the manufacturer.

8 CHECKING THE HYDRAULIC SYSTEM

→ If the motor switches on more than 10 times per hour in continuous operation (repumping), remove the motor actuator and send it to the manufacturer.

9 MAINTENANCE

⚠ CAUTION

In order to ensure smooth operation, check the tightness and function of the unit:

- Once per year, twice per year in the case of biogas; check for internal and external tightness, see page 4 (5 Tightness test).
- Check electrical installations once a year in line with local regulations; pay particular attention to the PE wire, see page 3 (4 Wiring).

→ If the flow rate has dropped, clean the strainer.

1 Disconnect the system from the electrical power supply.

2 Close the gas supply.

→ The lower housing cover is highly prestressed.

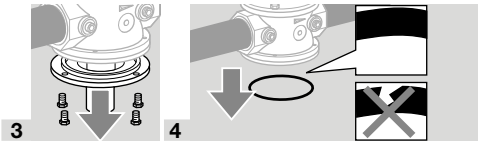

3

4

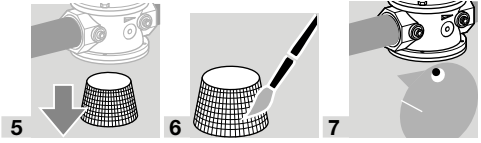

5

6

7

→ For biogas, check spring for corrosion and replace lower housing cover if necessary.

→ Spare part for lower housing cover, see PartDetective web app at www.adlatus.org.

→ Check the valve plate for signs of damage.

8 Once the seals have been replaced, follow the reverse procedure to reassemble the unit.

9 Then check the unit for internal and external tightness, see page 4 (5 Tightness test).

10 SPARE PARTS

The PartDetective web app for selecting spare parts is available at www.adlatus.org.

11 CONVERTING VK INTO VK..S OR VK..Z..S

⚠ DANGER

Risk of explosion!

Please observe the following to ensure that no damage occurs:

- The valve stem may not be pressed downwards either "manually" or using a tool after the motor actuator has been removed.

1 Disconnect the system from the electrical power supply.

2 Close the gas supply.

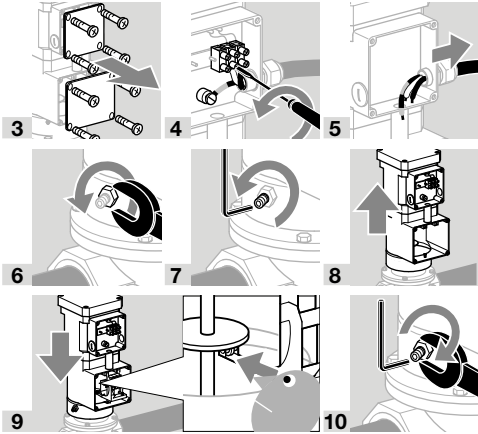

11 Follow the reverse procedure when reassembling.

12 Connect the VK to the electrical power supply, see page 3 (4 Wiring).

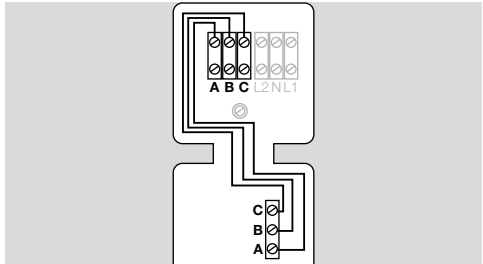
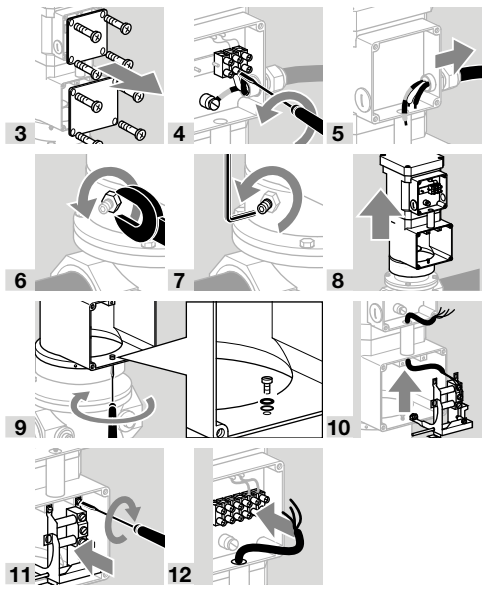

12 INSTALLING A CLOSED POSITION SWITCH

1 Disconnect the system from the electrical power supply.

2 Close the gas supply.

→ The circuit diagram shows the closed valve.

A = green

B = white

C = brown

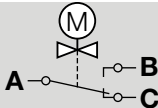

→ A-B closes as soon as the valve is open.

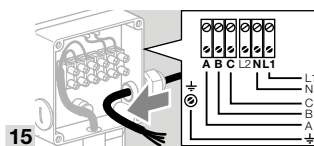
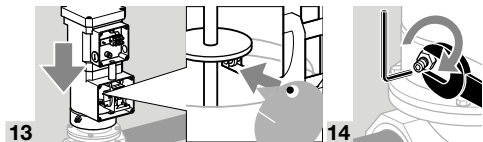

16 Switch on the system.

→ Turn the screw with an Allen key until the switch is actuated when the valve is open:

Clockwise = smaller stroke.

Anticlockwise = larger stroke.



18 Replace the cover and screw into place.

19 Open the gas supply.

13 INSTALLING TWO CLOSED POSITION SWITCHES

1 Disconnect the system from the electrical power supply.

2 Close the gas supply.

→ The circuit diagram shows the closed valve.

A = white

B = brown

C = yellow

L2 = green

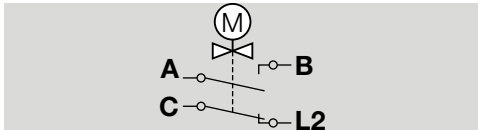

→ C-L opens as soon as the motorized valve starts to open.

→ A-B closes as soon as the valve is open.

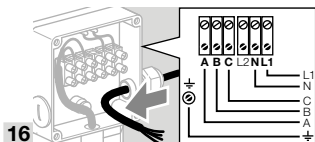
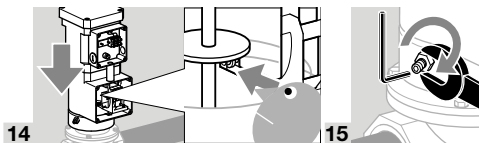
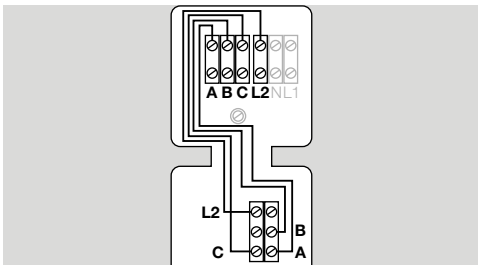
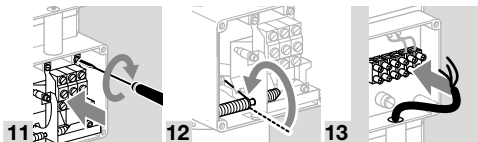
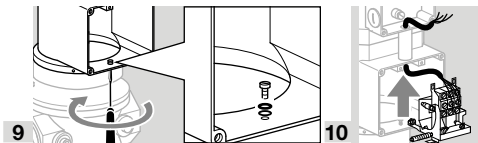
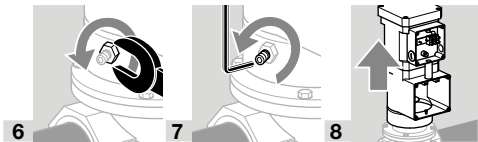
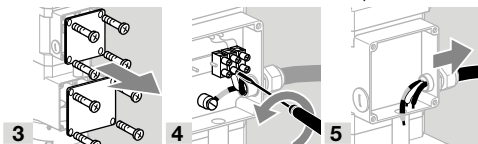

17 Switch on the system.

→ Turn the screw with an Allen key until the required start gas rate has been reached:

Clockwise = lower volume.

Anticlockwise = higher volume.

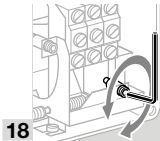

18

→ Turn the screw with an Allen key until the switch is actuated with the required stroke:

Clockwise = smaller stroke.

Anticlockwise = larger stroke.

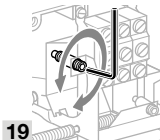

19

20 Replace the cover and screw into place.

21 Open the gas supply.

14 TECHNICAL DATA

14.1 Ambient conditions

Icing, condensation and dew in and on the unit are not permitted.

Avoid direct sunlight or radiation from red-hot surfaces on the unit.

Note the maximum medium and ambient temperatures!

Avoid corrosive influences, e.g. salty ambient air or SO₂.

The unit may only be stored/installed in enclosed rooms/buildings.

The unit is suitable for a maximum installation height of 2000 m AMSL.

Ambient temperature:

VK., VK..H, VK..Z: -15°C to +60°C,

VK..X, VK..HX: -15°C to +40°C.

Long-term use in the upper ambient temperature range accelerates the ageing of the elastomer materials and reduces the service life (please contact manufacturer).

Storage and transport temperatures: -20°C to +40°C.

Enclosure: IP 54,
safety class 1.

This unit is not suitable for cleaning with a high-pressure cleaner and/or cleaning products.

14.2 Mechanical data

Gas types: natural gas, town gas, LPG (gaseous), biogas (max. 0.1 %-by-vol. H₂S), landfill gas or clean air; other gases on request.

The gas must be dry in all temperature conditions and must not contain condensate.

Opening time:

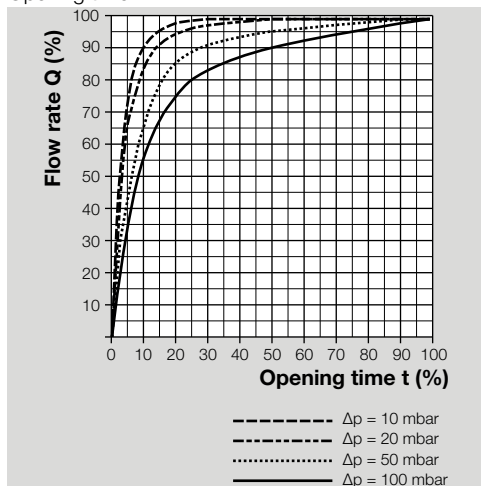

Nominal size	Opening time t VK	Opening time t VK..H
DN 40	5 s	-
DN 50–65	8 s	12 s
DN 80–100	10 s	18 s
DN 125–200	13 s	24 s
DN 250	-	24 s

Closing time: < 1 s.

Safety valve: Class A, Group 2 pursuant to EN 161.

Duty cycle: 100%.

Valve housing: aluminium, GGG 40 (coated inside and outside with epoxy powder coating).

Valve plate: Perbunan, Viton.

Motor actuator: AISi.

Internal thread: Rp to ISO 7-1.

Flange: ISO 7005, PN 16.

Medium temperature = ambient temperature.

14.3 Electrical data

Mains voltage:

220/240 V AC, +10/-15%, 50 Hz (standard),

230 V AC, +10/-15%, 50 Hz,

230 V AC, +10/-15%, 60 Hz,

220 V AC, +10/-15%, 50 Hz, 24 V DC,

200 V AC, +10/-10%, 50/60 Hz,

120 V AC, +10/-15%, 60 Hz,

110 V AC, +10/-15%, 50/60 Hz,

100 V AC, +10/-15%, 50/60 Hz.

Power consumption:

when opening: 90 VA, 50 W, open: 9 VA, 9 W.

Electrical connection:

– plug with socket to EN 175301-803,

– cable gland: M20,

– connection terminal: 2.5 mm².

15 DESIGNED LIFETIME

This information on the designed lifetime is based on using the product in accordance with these operating instructions. Once the designed lifetime has been reached, safety-relevant products must be replaced. Designed lifetime (based on date of manufacture) in accordance with EN 161 for VK:

Type	Designed lifetime	
	Switching cycles	Time (years)
VK 40 to 80	100,000	10
VK 100 to 125	50,000	10
VK 150 to 250	25,000	10

You can find further explanations in the applicable rules and regulations and on the afecor website (www.afecor.org).

This procedure applies to heating systems. For thermoprocessing equipment, observe local regulations.

16 CERTIFICATION

16.1 Certificate download

Certificates – see www.docuthek.com

16.2 Declaration of conformity



We, the manufacturer, hereby declare that the product VK with product ID No. CE-0063BL1552 complies with the requirements of the listed Directives and Standards.

Directives:

– 2014/35/EU – LVD

– 2014/30/EU – EMC

– 2011/65/EU – RoHS II

– 2015/863/EU – RoHS III

– 2014/68/EU – PED (VK 125–VK 200)

Regulation:

– (EU) 2016/426 – GAR

Standards:

– EN 161:2011+A3:2013

The relevant product corresponds to the tested type sample.

The production is subject to the surveillance procedure pursuant to Regulation (EU) 2016/426 Annex III paragraph 3 and for VK 125–VK 200 pursuant to Directive 2014/68/EU Annex III Module D1.

Elster GmbH

16.3 AGA listed



Australian Gas Association, Approval No.: 2726.

16.4 UKCA certified



Gas Appliances (Product Safety and Metrology etc. (Amendment etc.) (EU Exit) Regulations 2019)
BS EN 161:2011+A3:2013

16.5 Eurasian Customs Union



The products VK meet the technical specifications of the Eurasian Customs Union.

16.6 China RoHS

Directive on the restriction of the use of hazardous substances (RoHS) in China. Scan of the Disclosure Table China RoHS2, see certificates at www.docuthek.com.

16.7 REACH Regulation

The device contains substances of very high concern which are listed in the Candidate List of the European REACH Regulation No. 1907/2006. See Reach list HTS at www.docuthek.com.

17 LOGISTICS

Transport

Protect the unit from external forces (blows, shocks, vibration).

Transport temperature: see page 7 (14 Technical data).

Transport is subject to the ambient conditions described.

Report any transport damage on the unit or packaging without delay.

Check that the delivery is complete.

Storage

Storage temperature: see page 7 (14 Technical data).

Storage is subject to the ambient conditions described.

Storage time: 6 months in the original packaging before using for the first time. If stored for longer than this, the overall service life will be reduced by the corresponding amount of extra storage time.

18 DISPOSAL

Devices with electronic components:

WEEE Directive 2012/19/EU – Waste Electrical and Electronic Equipment Directive



At the end of the product life (number of operating cycles reached), dispose of the packaging and product in a corresponding recycling centre. Do not dispose of the unit with the usual domestic refuse. Do not burn the product. On request, old units may be returned carriage paid to the manufacturer in accordance with the relevant waste legislation requirements.

FOR MORE INFORMATION

The Honeywell Thermal Solutions family of products includes Honeywell Combustion Safety, Eclipse, Exothermics, Hauck, Kromschöder and Maxon. To learn more about our products, visit ThermalSolutions.honeywell.com or contact your Honeywell Sales Engineer.

Elster GmbH
Strotheweg 1, D-49504 Lotte
T +49 541 1214-0
hts.lotte@honeywell.com
www.kromschroeder.com

Global centralized service deployment coordination:
T +49 541 1214-365 or -555
hts.service.germany@honeywell.com

Translation from the German
© 2022 Elster GmbH

Honeywell
krom
schroder