

03250885

**krom
schroder**

D GB F NL I E DK S N GR
TR CZ PL AUS H → www.docuthek.com

Operating instructions
Safety shut-off valve
JSAV 50 – 100



Contents

Safety shut-off valve JSAV 50 – 100 1

Contents 1

Safety 1

Checking the usage 2

Type code 2

Part designations 2

Type label 2

Installation 2

Connecting the impulse line 3

Connecting the breather line 3

Tightness test 3

Checking the function 4

Checking the trip pressure p_{do} 4

Checking the tightness of the valve disc 4

Setting the trip pressure p_{do} 4

Replacing the spring 4

Resetting 5

Replacing the measuring unit 5

Replacing the valve disc 5

Maintenance 6

Accessories 6

Technical data 7

Designed lifetime 7

Logistics 8

Certification 8

Declaration of conformity 8

Eurasian Customs Union 8

Contact 8

Safety

Please read and keep in a safe place



Please read through these instructions carefully before installing or operating. Following the installation, pass the instructions on to the operator. This unit must be installed and commissioned in accordance with the regulations and standards in force. These instructions can also be found at www.docuthek.com.

Explanation of symbols

■, **1**, **2**, **3**... = Action
 > = Instruction

Liability

We will not be held liable for damage resulting from non-observance of the instructions and non-compliant use.

Safety instructions

Information that is relevant for safety is indicated in the instructions as follows:

⚠ DANGER

Indicates potentially fatal situations.

⚠ WARNING

Indicates possible danger to life and limb.

! CAUTION

Indicates possible material damage.

All interventions may only be carried out by qualified gas technicians. Electrical interventions may only be carried out by qualified electricians.

Conversion, spare parts

All technical changes are prohibited. Only use OEM spare parts.

Changes to edition 03.18

The following chapters have been changed:

- Technical data
- Logistics
- Certification

Checking the usage

JSAV

Safety shut-off valve for securing downstream fittings against excess gas pressure.

This function is only guaranteed when used within the specified limits—see page 7 (Technical data).

Any other use is considered as non-compliant.

Type code

Code	Description
JSAV	Safety shut-off valve
50-100	Nominal size
T	T-product
F	Flange to ISO 7005
A	ANSI flange
50	Inlet pressure $p_{u \max.} = 5 \text{ bar (72.5 psig)}$
/1	Over-pressure shut-off p_{do}
-0	No pressure test point

Part designations

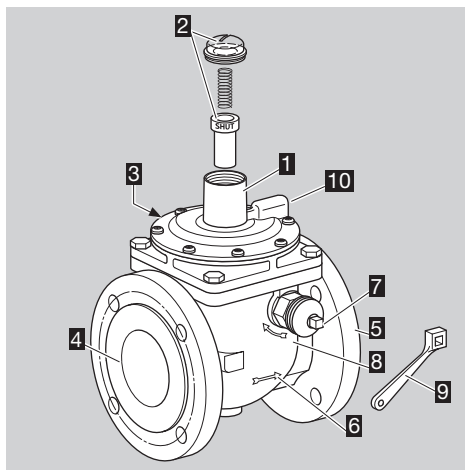

- 1** Measuring unit
- 2** Screw plug with position indicator
- 3** Connection for impulse line (closed with plastic plug)
- 4** Inlet
- 5** Outlet
- 6** Arrow of direction of flow
- 7** Reset
- 8** Arrow of direction of reset
- 9** Reset lever
- 10** Connection for breather line (closed with plastic plug)

Type label

Max. inlet pressure, upper trip pressure p_{do} , ambient temperature: see type label.

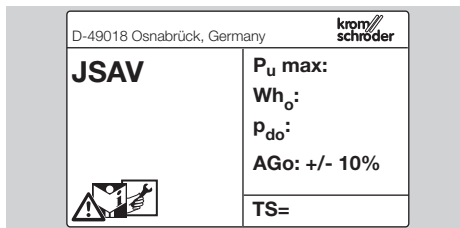

Installation

! CAUTION

Please observe the following to ensure that the JSAV is not damaged during installation:

- Sealing material, cuttings and other impurities must not be allowed to get into the housing.
- We recommend installing a filter upstream of the JSAV in order to protect it against impurities in the pipe.
- The installation location must be dry. Do not store or install the JSAV in the open air.
- Dropping the device can cause permanent damage. In this event, replace the entire device and associated modules before use.
- Install the JSAV in the pipe free of mechanical stress.
- Do not clamp the unit in a vice or use it as a lever. Risk of external leakage.
- Max. inlet pressure $p_{u \max.} 5 \text{ bar (72.5 psig)}$.
- Installation in the vertical or horizontal position, never upside down.

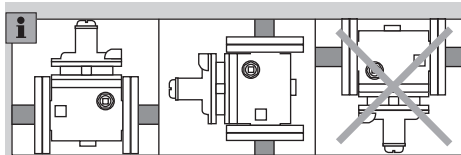

- 1** The housing must not be in contact with masonry. Minimum clearance 20 mm (0.78"). Ensure that there is sufficient space for installation and adjustment.
 - 2** Remove the adhesive foil from the inlet and outlet on the JSAV.
 - 3** Insert seal between pipe and unit.
- ▷ Note direction of flow.

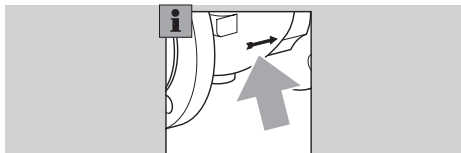

- ▷ We recommend installing a manual valve AKT 25 in the pipe leading to the safety relief valve VSBV 25, so that the annual function check of the safety shut-off valve JSAV can be carried out without having to remove it.
- ▷ To prevent the VSBV from being unintentionally shut off, we recommend removing the manual valve lever after commissioning and attaching it to the pipe.

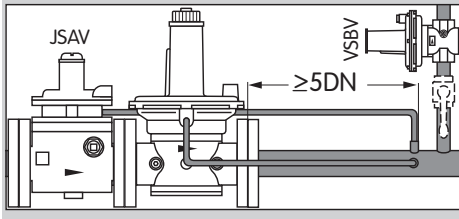

Connecting the impulse line

- ▷ Remove the plastic plug in the “impulse line” connection and connect an Rp ¼ (¼ NPT) pipe. We recommend a pipe diameter of 12 x 1.5 mm.
- 1** Install the impulse line and seal with an approved sealing material.
- ▷ Ensure that there is sufficient tube length for the impulse line.

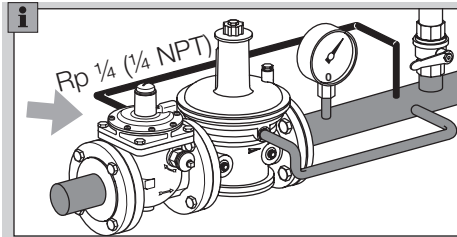

Connecting the breather line

- ▷ Remove the plastic plug in the “breather line” connection and connect an Rp ¼ (¼ NPT) pipe. We recommend a pipe diameter of 12 x 1.5 mm.
- 1** Install the breather line and seal with approved sealing material.
- ▷ Route the breather line to a safe area.

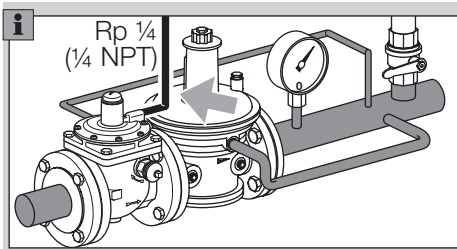

Tightness test

⚠ WARNING

- If gas-filled spaces have been opened for maintenance work or replacement of spare parts, an additional tightness test must be carried out on the affected joints.
- ▷ Ensure that the valve seat of the JSAV is open, see page 5 (Resetting).
- 1** Block the pipeline at the inlet and outlet.
- ▷ Note max. test pressure.
JSAV inlet and outlet: max. 7.5 bar (109 psig),
impulse line: max. 750 mbar (10.9 psig).
- 2** Slowly apply test pressure.

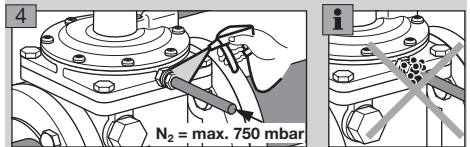
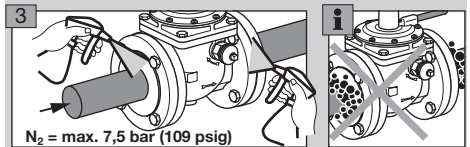
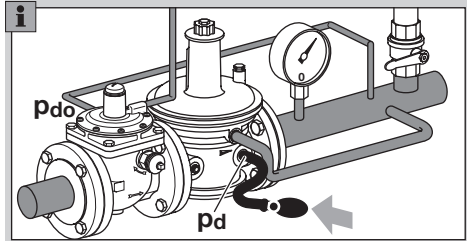

Checking the function

Checking the trip pressure p_{do}

The JSAV is checked for the required trip pressure p_{do} .

- 1 Vent the system.
 - ▷ Ensure that the valve seat of the JSAV is open, see page 5 (Resetting).
 - ▷ Ensure that the breather screw plug is screwed in.
- 2 Close all manual valves at the inlet and outlet, and in the relief line.

! CAUTION

Please observe the following to ensure that the regulator is not damaged during the function check:

- Do not exceed the maximum outlet pressure p_d of the regulator.
- 3 Increase the outlet pressure p_d on the regulator until the required trip pressure p_{do} is reached.

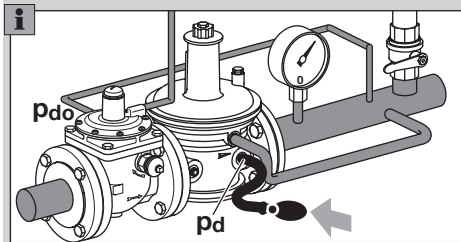

- ▷ The JSAV closes at the set trip pressure p_{do} . The red "SHUT" mark is visible.

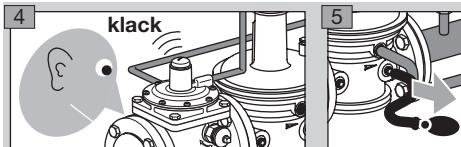

- ▷ The JSAV has closed successfully: to restart the system, the JSAV must be opened again, see page 5 (Resetting).
- ▷ The JSAV does not close at the required trip pressure p_{do} and must be readjusted, see page 4 (Setting the trip pressure p_{do}).

Checking the tightness of the valve disc

- ▷ Ensure that the JSAV and outlet gas line are closed.
- 1 Vent the system.
 - 2 Slowly open the manual valve at the inlet.
 - 3 The outlet pressure p_d must not rise.

Setting the trip pressure p_{do}

- 1 Select the trip pressure p_{do} according to the outlet pressure p_d of the pressure regulator.

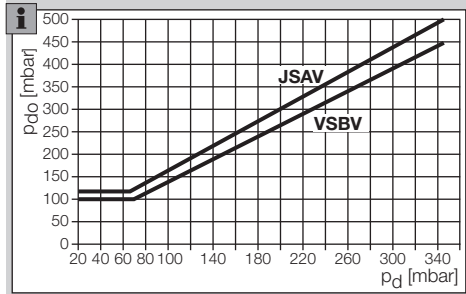

- 2 Remove the screw plug.
 - ▷ Set the trip pressure p_{do} according to the diagram.

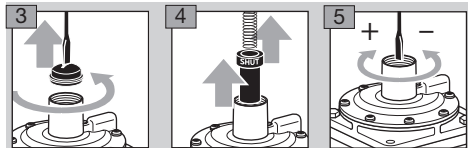

- ▷ If the JSAV has tripped, i.e. the "SHUT" mark is visible, reset it – see page 5 (Resetting).
- 6 Check the required trip pressure p_{do} again, see page 4 (Checking the function).
 - 7 If the JSAV has been adjusted correctly, follow the reverse procedure when reassembling.

Replacing the spring

- ▷ Various trip pressure ranges can be achieved by using different springs on the JSAV.
- 1 Choose a spring according to the required trip pressure range.

Spring table			
Trip pressure p_{do} [mbar]	Trip pressure p_{do} [psig]	Marking	Order No.
35–70	0.51–1.02	light blue	0 308 906 3
60–170*	0.9–2.5	reddish brown	0 308 906 4
120–220	1.74–3.2	violet	0 308 906 5
190–400	2.8–5.8	orange/yellow	0 308 906 6
300–550	4.35–8	orange/green	0 308 906 7

* Standard spring

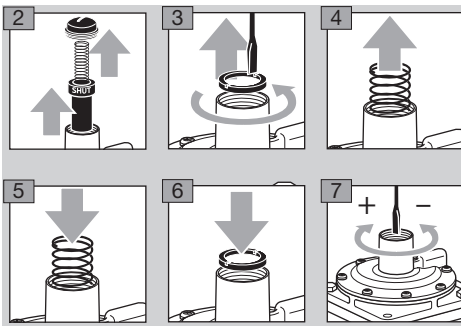

- 8 Set the required trip pressure p_{do} , see page 4 (Setting the trip pressure p_{do}).
- 9 Follow the reverse procedure when reassembling.
- 10 After inserting the spring, take the spring's label from the packaging and stick it below the type label on the JSAV.
- 11 Clearly mark the adjusted value of the trip pressure p_{do} on the sticker.

Resetting

- ▷ Ensure that the impulse line is depressurized.

! CAUTION

Please observe the following to ensure that the JSAV is not damaged during resetting:

- Turn the reset lever gently and do not go further than specified.

- 1 Press the reset lever and turn through 10° until resistance can be felt.

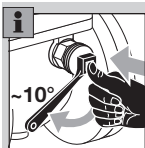

- 2 Hold the reset lever in this position until the lever can be easily turned further following pressure equalization.
 - 3 Press and turn the reset lever until the valve disc opens and clicks into place and the "SHUT" mark is no longer visible.
- ▷ The red "SHUT" mark must not be visible once the valve disc has clicked into place.
 - ▷ The JSAV is ready for operation.

Replacing the measuring unit

- ▷ The measuring unit has to be replaced if the JSAV no longer opens or can no longer be reset.
- ▷ We recommend cleaning the O-ring seats and lightly greasing the O-rings with Klüber Nontrop ZB91 DIN before installation.

- 1 Depressurize the system.
 - ▷ The measuring unit is supplied with 1 O-ring and 4 screws.
- 2 Ensure that the JSAV is closed. The red "SHUT" mark must be visible.
 - ▷ If the JSAV is open, apply pressure to the impulse line to close the valve.
- 3 Detach the impulse and breather lines from the JSAV.

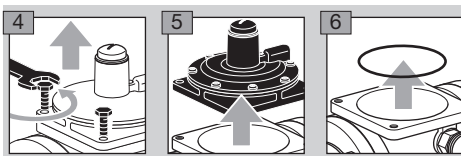

- 7 Install the new O-ring in the housing.
- 8 Follow the reverse procedure when reassembling.
- 9 Connect the impulse and breather lines to the JSAV.
- 10 Check tightness and function, see page 3 (Tightness test) and page 4 (Checking the function).

Replacing the valve disc

- ▷ The valve disc has to be replaced if the JSAV is leaking or has been damaged during resetting.
- ▷ We recommend cleaning the O-ring seats and lightly greasing the O-rings with Klüber Nontrop ZB91 DIN before installation.

- 1 Depressurize the system.
 - ▷ We also recommend replacing the entire seal set and the bellows when replacing the valve disc.
 - ▷ The seal set with bellows is available separately as a spare part.
 - ▷ Ensure that the JSAV is closed. The red "SHUT" mark must be visible.
 - ▷ If the JSAV is open, apply pressure to the impulse line to close the valve.
- 2 Detach the impulse and breather lines from the JSAV.

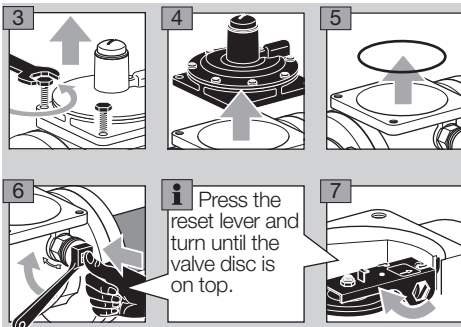

⚠ WARNING

Risk of injury!

- The spring wire is under high stress.

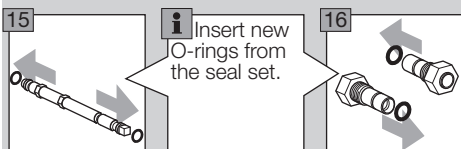
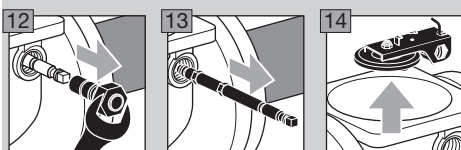
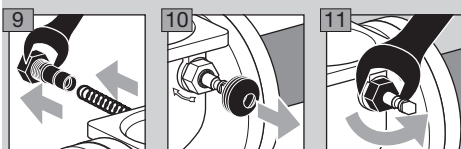
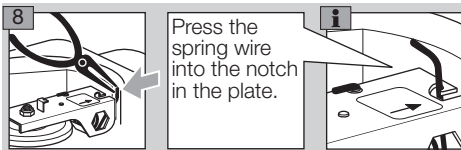

17 Follow the reverse procedure when reassembling using the new valve disc and the O-rings from the seal set.

- ▷ To ensure that the valve disc is pushed onto the seat by the spring, the spring wire must be released from the notch in the plate and rest against the housing wall.

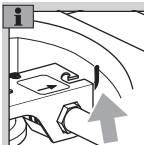

18 Connect the impulse and breather lines.

19 Check tightness and function, see page 3 (Tightness test) and page 4 (Checking the function).

Maintenance

In order to ensure smooth operation: check the function and tightness of the JSAV every year, or every six months if operated with biogas, see page 4 (Checking the function) and page 3 (Tightness test).

- ▷ In the case of malfunctioning, check the measuring unit and valve disc and replace if necessary.
 - Selecting spare parts: see www.adlatus.org, PartDetective.
 - Replacing spare parts: see page 5 (Replacing the measuring unit), see page 5 (Replacing the valve disc).
- ▷ After carrying out maintenance work or replacing spare parts, check for tightness and function, see page 3 (Tightness test) and page 4 (Checking the function).

Accessories

Position switch for remote indication

The position switch can be used for electronic position checks.

Order No.: 03151185

Part designations

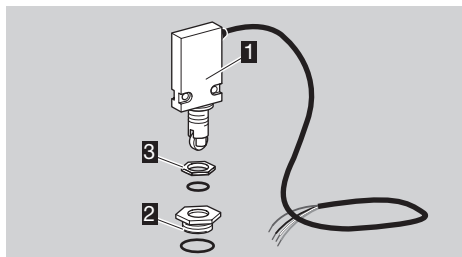

- 1** Position switch
- 2** Aluminium turned part
- 3** Lock nut

Two washers and another lock nut which are included in the delivery are not required.

- 1** Ensure that the JSAV is open. The red "SHUT" mark is not visible.

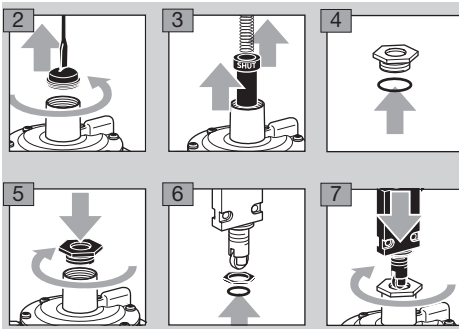

- 8** Screw in the position switch until the switching point is reached and then screw in a further half a turn.
 - ▷ See the drawing labelled “Contacts” in the enclosed position switch installation and connection instructions for measuring the switching point.
- 9** Prevent the position switch from rotating using the fitted lock nut.
- 10** Wire the position switch.
 - ▷ See the drawing labelled “Contacts” in the enclosed position switch installation and connection instructions for the electrical wiring.
- 11** After wiring, check for correct functioning, see page 4 (Checking the function).

Technical data

Ambient conditions

Icing, condensation and dew in and on the unit are not permitted.

Avoid direct sunlight or radiation from red-hot surfaces on the unit. Note the maximum medium and ambient temperatures!

Avoid corrosive influences, e.g. salty ambient air or SO₂.

The unit may only be stored/installed in enclosed rooms/buildings.

Ambient temperature:

-15 to +60°C (5 to 140°F).

Long-term use in the upper ambient temperature range accelerates the ageing of the elastomer materials and reduces the service life (please contact manufacturer).

This unit is not suitable for cleaning with a high-pressure cleaner and/or cleaning products.

Mechanical data

Gas type: natural gas, town gas, LPG (gaseous), biogas (max. 0.02 %-by-vol. H₂S) = Group 1 fluids pursuant to Directive 2014/68/EU or air.

Medium temperature = ambient temperature.

The gas must be dry in all temperature conditions and must not contain condensate.

Max. inlet pressure $p_{u \max}$: 5 bar (72.5 psig).

Max. test pressure for testing the JSAV: temporarily < 15 min. 7.5 bar (109 psig).

Max. test pressure for testing the impulse line: temporarily < 15 min. 750 bar (10.8 psig).

Trip pressure p_{do} set at the factory: 120 mbar (46.8 "WC).

Adjusting range for trip pressure p_{do} , see page 4 (Replacing the spring), Spring table.

Accuracy group: AG 10.

Connection for housing:

JSAV.F: flange to ISO 7005,

JSAV.A: ANSI flange.

Connection for impulse and breather lines:

Rp ¼ (¼ NPT).

Housing: GGG 40.

Diaphragm: NBR,

valve seat: aluminium,

valve stem: stainless steel,

valve disc: aluminium with vulcanized NBR seal.

valve stem: stainless steel,

valve disc: aluminium with vulcanized NBR seal.

Designed lifetime

This information on the designed lifetime is based on using the product in accordance with these operating instructions. Once the designed lifetime has been reached, safety-relevant products must be replaced. Designed lifetime (based on date of manufacture) in accordance with DIN EN 14382 Safety devices for gas pressure regulating stations and installations: 10 years.

You can find further explanations in the applicable rules and regulations and on the afecor website (www.afecor.org).

This procedure applies to heating systems. For thermoprocessing equipment, observe local regulations.

Logistics

Transport

Protect the unit from external forces (blows, shocks, vibration).

Transport temperature: -15 to +60°C (5 to 140°F).

Transport is subject to the ambient conditions described.

Report any transport damage on the unit or packaging without delay.

Check that the delivery is complete, see page 2 (Part designations).

Storage

Storage temperature: -15 to +40°C (5 to 104°F).

Storage is subject to the ambient conditions described.

Storage time: 6 months before using for the first time. If stored for longer than this, the overall service life will be reduced by the corresponding amount of extra storage time.

Packaging

The packaging material is to be disposed of in accordance with local regulations.

Disposal

Components are to be disposed of separately in accordance with local regulations.

Certification

Declaration of conformity



We, the manufacturer, hereby declare that the product JSAV 50 – 100 with product ID No. CE-0085CO0530 complies with the requirements of the listed Directives and Standards.

Directives:

– 2014/68/EU – PED

Regulation:

– (EU) 2016/426 – GAR

Standards:

– DIN EN 14382:2009

The relevant product corresponds to the tested type sample.

The production is subject to the surveillance procedure pursuant to Regulation (EU) 2016/426 Annex III and to Directive 2014/68/EU Annex III Module D1.

This declaration of conformity is issued under the sole responsibility of the manufacturer.

Elster GmbH

Scan of the Declaration of conformity (D, GB), see www.docuthek.com.

Eurasian Customs Union



The product JSAV meets the technical specifications of the Eurasian Customs Union.

Contact

If you have any technical questions, please contact your local branch office/agent. The addresses are available on the Internet or from Elster GmbH.

We reserve the right to make technical modifications in the interests of progress.

Honeywell

**krom//
schroder**

Elster GmbH

Strotheweg 1, D-49504 Lotte (Büren)

Tel. +49 541 1214-0

Fax +49 541 1214-370

hts.lotte@honeywell.com, www.kromschroeder.com